



**Home Theater  
Standard 7.1  
Surround  
Preamp/Processor**

---

**Instructions for Use**

**Owner's Reference**

---

# Home Theater Standard 7.1

## Surround Preamp/Processor

### Instructions for Use

v 02.3

#### CONTACT INFORMATION

Krell Industries, Inc.  
45 Connair Road  
Orange, CT 06477-3650 USA

TEL 203-799-9954  
FAX 203-891-2028  
E-MAIL [krell@krellonline.com](mailto:krell@krellonline.com)  
WEBSITE <http://www.krellonline.com>



This product complies with the EMC directive (89/336/EEC) and the low-voltage directive (73/23/EEC).

#### WARNINGS

The Home Theater Standard 7.1 must be placed on a firm level surface where it is not exposed to dripping or splashing.

The ventilation grids on the top and bottom of the Home Theater Standard 7.1 must be unobstructed at all times during operation. Do not place flammable material above or beneath the component.

Do not remove or bypass the ground pin on the end of the AC power cord. This could cause radio frequency interference (RFI) to be introduced into your playback system.

Before making connections to the Home Theater Standard 7.1, make sure the back panel power switch is off. Make sure all cable terminations are of the highest quality and free from frayed ends, short circuits, or cold solder joints.

**THERE ARE NO USER SERVICEABLE PARTS INSIDE ANY KRELL PRODUCT.**  
Please contact your authorized Krell dealer, distributor, or Krell if you have any questions not addressed in this Owner's Reference.

DTS Digital Surround™ is a discrete 5.1 channel digital audio format available on CD, LD, and DVD software which consequently cannot be decoded and played back inside most CD, LD, or DVD players. For this reason, when DTS-encoded software is played back through the analog outputs of the CD, LD, or DVD player, excessive noise will be exhibited. To avoid possible damage to the audio system, proper precautions should be taken by the consumer if the analog outputs are connected directly to an amplification system. To enjoy DTS Digital Surround™ playback, an external 5.1 channel DTS Digital Surround™ decoder system must be connected to the digital output (S/PDIF, AES/EBU, or TosLink) of the CD, LD, or DVD player.

This product is manufactured in the United States of America. Krell® is a registered trademark of Krell Industries, Inc., and is restricted for use by Krell Industries, Inc., its subsidiaries, and authorized agents. Krell Current Mode™ and Smart System Setup™ are trademarks of Krell Industries, Inc. "DTS", "DTS Digital Surround", "DTS ES Extended Surround", and "Neo:6" are registered trademarks of Digital Theater Systems, Inc. TosLink is a trademark of Toshiba Corporation. Manufactured under license from Dolby Laboratories. "Dolby," "Pro Logic," and the double-D symbol are trademarks of Dolby Laboratories. Confidential Unpublished Works. Copyright 1992–1997 Dolby Laboratories, Inc. All rights reserved. THX is a registered trademark of Lucasfilm, Ltd. Re-Equalization, Timbre Matching, and Decorrelation are trademarks of Lucasfilm, Ltd. All other trademarks and trade names are registered to their respective companies.

---

# Contents

	<b>Page</b>
INTRODUCTION	1
DEFINITION OF TERMS	2
UNPACKING	4
PLACEMENT	5
AC Power Guidelines	5
GETTING STARTED	6
An Introduction to System Setup and Operation	6
FRONT PANEL DESCRIPTION	8
BACK PANEL DESCRIPTION	14
REMOTE CONTROL DESCRIPTION	17
Battery Installation and Removal	17
CONNECTING THE HOME THEATER STANDARD TO YOUR SYSTEM	22
Step 1: Power Off and Prepare Wiring	22
Step 2: Connect Analog Sources	22
Step 3: Connect Digital Sources	23
Step 4: Match Video Formats and Signals	24
Step 5: Connect Video Sources and the Video Monitor	25
Step 6: Activating the On Screen Display (OSD)	26
Step 7: Connect Amplifiers and Loudspeakers	27
OVERVIEW: SYSTEM CONFIGURATION AND NAVIGATION	28
Configuration Steps	32
Navigation Conventions	33
SYSTEM CONFIGURATION	34
Accessing the Main Menu	34
Step 1: Configure Loudspeakers	35
Step 2: Listening Room Setup	37
Step 3: Calibrate Volume	38
Step 4: Configure Devices	40
Step 5: Configure Level Adjustment	49
Step 6: Operation	58
SAVING AND RECALLING CUSTOMIZED SETTINGS AND RESTORING THE FACTORY DEFAULT SYSTEM SETTINGS	70
OPERATING THE HOME THEATER STANDARD 7.1	71
On/Off/Stand-by, Tape Input and Output	71
Main Zone and Zone 2 Operation	72
Simulcast	73
APPENDIX: HOME THEATER STANDARD 7.1 OPERATING MODES	75
Automatically Detected Modes	75
User Selectable Modes	76
WARRANTY	78
RETURN AUTHORIZATION PROCEDURE	79
SPECIFICATIONS	80

---

## Tables

	<b>Page</b>	
TABLE 1	Factory Default Video Inputs and Standards for the Home Theater Standard 7.1, North American Operation	41
TABLE 2	Factory Default Video Inputs and Standards for the Home Theater Standard 7.1, International Operation	41
TABLE 3	Factory Default Digital and Analog Inputs for the Home Theater Standard 7.1, North American and International Operation	43
TABLE 4	Home Theater Standard 7.1 Factory Default Audio Operating Modes	44
TABLE 5	Krell Music Surround Modes for the Home Theater Standard 7.1	77

---

## Illustrations

	<b>Page</b>	
FIGURE 1	The Home Theater Standard 7.1 Front Panel	7
FIGURE 2	The Home Theater Standard 7.1 Back Panel	13
FIGURE 3	The Home Theater Standard 7.1 Remote Control	17
FIGURE 4	Source Selection Buttons, Factory Default Video Signals, and Video Formats for the Home Theater Standard 7.1, North American Operation	25
FIGURE 5	Source Selection Buttons, Factory Default Video Signals, and Video Formats for the Home Theater Standard 7.1, International Operation	26

---

# Introduction

Thank you for your purchase of the Krell Home Theater Standard 7.1 Surround Preamp/Processor.

The Home Theater Standard 7.1 surround preamp/processor serves as the centerpiece in a Krell HEAT™—High End Audio Theater—system, which applies the fundamental principles of Krell engineering to the creation of a fully integrated high-performance multichannel sound system. The Home Theater Standard 7.1 delivers unparalleled music and cinema soundtrack reproduction through the use of a full complement of advanced Krell technologies including Krell Current Mode™, Smart System Setup™, discrete Class A, direct-coupled circuitry with balanced outputs, user-configurable input assignment and system macros, main and remote zone control capability, the Krell Digital Room Equalizer, and broadcast-quality video circuitry.

The Home Theater Standard 7.1 is THX Ultra certified and features THX Surround EX, Dolby Digital 5.1, Dolby Digital EX, DTS 6.1 ES, DTS NEO:6, and Dolby Pro Logic II processing, in addition to nine proprietary Krell Music Surround modes. The flexibility and modular architecture of the Home Theater Standard 7.1 allows upgrades to internal hardware and software for future surround sound formats and design enhancements.

This owner's reference manual contains important information on the placement, installation, and operation of the Krell Home Theater Standard 7.1. Please read this information carefully. A thorough understanding of these details helps ensure satisfactory operation of and long life for your Home Theater Standard 7.1 and related system components.

---

## Definition of Terms

Following are the definitions of key terms used in your owner's reference manual:

### INPUT AND OUTPUT CONNECTIONS

#### **Balanced**

A symmetrical input or output circuit that has equal impedance from both input terminals to a common ground reference point. The industry standard for professional and sound recording installations, balanced connections have 6 dB more gain than single-ended connections and allow the use of long interconnect cables. Balanced connections are immune to induced noise from the system or the environment.

#### **Multichannel (DB-25)**

A balanced input or output circuit that allows for the simultaneous connection of all audio outputs plus one 5 VDC (5 Volt trigger) via a single cable. DB-25 inputs and outputs are becoming popular for connecting an audio/video surround sound processor and power amplifiers, simplifying the integration of the two components into your system.

#### **Single-ended**

A two-wire input or output circuit. Use care when using single-ended connections as the ground connection is made last and broken first. Turn the system off prior to making or breaking single-ended connections. Single-ended connections are not recommended for connections requiring long cable runs.

### OPERATION

#### **Off**

When the power switch on the back panel is placed in the down position and LEDs turn off, the component is off.

#### **Stand-by Mode**

When the HTS is connected to AC power and the back panel power switch is in the up (on) position, the red stand-by LED illuminates. This indicates that the component is in stand-by mode, a low power consumption status that keeps the audio and regulator circuits at idle. Krell recommends leaving the component in the stand-by mode when it is not playing music.

#### **Operational Mode**

When the component is in the stand-by mode, and you press the power button on the front panel or the power key on the remote control, the blue power LED illuminates. The component is in the operational mode and is ready to play music.

## TECHNOLOGY

### **Krell Current Mode**

A proprietary Krell circuit topology in which the audio gain stages of a component operate in the current rather than the voltage domain. This unique technology provides the component with exceptional speed and a wide bandwidth.

### **Krell HEAT**

The Krell term HEAT, or High End Audio Theater, is a design application incorporated into Krell components to enhance multi-channel home entertainment systems. A Krell HEAT system is an integrated home theater system consisting of a state-of-the-art Krell preamp/processor and matching amplifiers that reproduce two channel and multi-channel sources with audiophile sound quality, placing the audience in the middle of a lifelike environment.

## VIDEO

### **Component Video Signal**

A video signal that uses three wires to convey luminance (Y), blue minus luminance (B-Y), and red minus luminance (R-Y) signals. Component video signals may be interlaced or progressive:

**Interlaced signals** build screen content in two passes.

**Progressive signals** build screen content in one pass. This technology eliminates motion artifacts and produces film-quality pictures. Both your source and video monitor must be equipped with progressive video technology to realize this advantage.

### **S-Video Signal**

Video signal that separately transmits the luminance (Y) and color (C) components of the video signal using one wire. The s-video signals bypass television circuitry required by composite video, and reduces video noise as well as cross-contamination of color and black and white signals.

### **Composite Video Signal**

An encoded video signal that transmits luminance (Y) and color (C) information on one wire.

### **YCbCr (YPbPr)**

One way to designate different color signals used in component video. Y = the luminance signal, Cb = the blue minus luminance (B-Y) signal, and Cr = the red minus luminance (R-Y) signal. The component video color signals are also designated as YPbPr.

---

# Unpacking

Open the box and remove the top layer of foam. You see these items:

- 1 Home Theater Standard 7.1
- 1 IEC connector (AC power) cord
- 1 Home Theater Standard 7.1 handheld remote control
- 1 CR2025 lithium battery
- 1 T-15 Torx wrench (small L type)
- 1 T-10 Torx wrench (small L type)
- 1 12 VDC output (12 V trigger) cable
- 1 packet containing the owner's reference manual, the "read this first" insert, and the warranty registration card.

Carefully remove the unit and accessories from the box. Remove the foam end caps and protective plastic wrap from the unit.

---

## **Note**

*If any of these items are not included in the shipping box, please contact your authorized Krell dealer, distributor, or Krell for assistance. Save all packing materials. If you must ship your Home Theater Standard in the future, repack the unit in its original packaging to prevent damage in transit. See **Return Authorization Procedure**, on page 79.*



---

## Placement

Before you install the Home Theater Standard 7.1 into your system, review the following guidelines to choose the location for the component. This will facilitate a clean, trouble-free installation.

The Home Theater Standard 7.1 does not require any type of special rack or cabinet for installation. For the dimensions of your Home Theater Standard 7.1 see **Specifications**, on pages 80-81.

The Home Theater Standard 7.1 requires at least two inches (5 cm) of clearance on each side and at least two inches (5 cm) of clearance above and below the component to provide adequate ventilation. In addition, the Home Theater Standard 7.1 requires at least three inches (7 cm) of clearance between other connected components. For installations inside cabinetry, extra ventilation may be necessary.

### AC POWER GUIDELINES

The Home Theater Standard 7.1 has superb regulation and does not require a dedicated AC circuit. Avoid connections through extension cords or multiple AC adapters. High quality 15 amp grounded AC strips are acceptable.

High quality AC line conditioners or filters may be used if they are grounded and meet or exceed the unit's power supply rating of 100 VA. Contact your authorized Krell dealer, distributor, or Krell before using any devices designed to alter or stabilize the AC power for the Home Theater Standard 7.1.

The Home Theater Standard 7.1 should be used only with the power cord supplied.

---

# Getting Started

## AN INTRODUCTION TO SYSTEM SETUP AND OPERATION

The Home Theater Standard 7.1 provides comprehensive connection and operation options for outstanding music and cinema soundtrack reproduction. To take full advantage of the features the Home Theater Standard 7.1 offers, we recommend that you set up your system for operation in the following order:

1. Review the features of the Home Theater Standard 7.1. See **Front Panel Description**, on page 8, **Rear Panel Description**, on page 14, and **Remote Control Description**, on page 18.
2. Connect the Home Theater Standard 7.1 to your analog and digital audio sources. See **Connecting the Home Theater Standard 7.1 to Your System**, on page 22.
3. Select the video format (NTSC Interlaced for North America or PAL Interlaced overseas) for your monitor and select the video signal you want to use (component, s-video, or composite) for each video source in your system. See **Match Video Formats and Signals**, on page 24.
4. Connect the video sources and video monitor to the Home Theater Standard 7.1. See **Connecting Video Sources and the Video Monitor**, on page 25.
5. Make sure that the OSD is visible, by pressing the menu key (82). See **Activating the On Screen Display (OSD)**, on page 26.
6. Connect the rest of the components in the system. See **Connect Amplifiers and Loudspeakers**, on page 27.
7. Using the remote control and the OSD, configure each device in the system with Smart System Setup™ and the built-in, easy-to-follow system configuration menus. See **System Configuration**, on page 34.
8. After you have connected and configured the Home Theater Standard 7.1 and related system components, and are familiar with the basic features of the Home Theater Standard 7.1, you are ready to switch to the operational mode. See **Operating the Home Theater Standard 7.1**, on page 71.

**Figure 1 The Home Theater Standard 7.1 Front Panel**

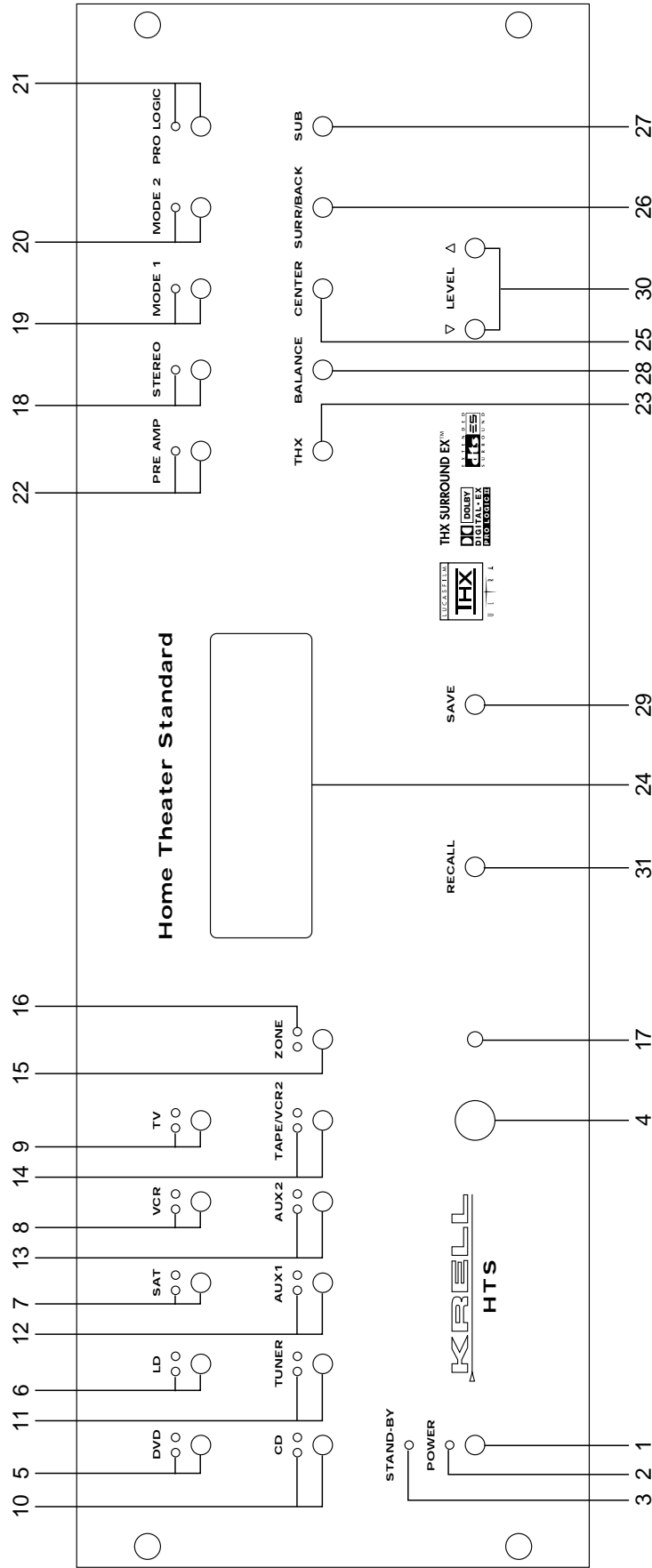

- |                         |                                    |                                |                               |
|-------------------------|------------------------------------|--------------------------------|-------------------------------|
| <b>Basic Operation</b>  | <b>Device Selection</b>            | <b>Processing Mode</b>         | <b>Individual Channel</b>     |
| 1 Power Button          | <b>Buttons and LEDs, continued</b> | <b>Buttons and LEDs</b>        | <b>Trim Buttons</b>           |
| 2 Power LED             | 9 TV Button and LEDs               | 18 Stereo Button and LED       | 25 Center Button              |
| 3 Stand-by LED          | 10 CD Button and LEDs              | 19 Mode 1 Button and LED       | 26 Surr/Back Button           |
| 4 Infrared Sensor       | 11 Tuner Button and LEDs           | 20 Mode 2 Button and LED       | 27 Sub Button                 |
| <b>Device Selection</b> | 12 Aux1 Button and LEDs            | 21 Pro Logic II Button and LED | 28 Balance Button             |
| <b>Buttons and LEDs</b> | 13 Aux2 Button and LEDs            | 22 Preamp Button and LED       | <b>Processor Function</b>     |
| 5 DVD Button and LEDs   | 14 Tape/VCR2 Button and LEDs       | 23 THX Button                  | <b>Buttons</b>                |
| 6 LD Button and LEDs    | 15 Main Zone and Zone 2 Button     | <b>Display</b>                 | 29 Save Button                |
| 7 SAT Button and LEDs   | 16 Main Zone and Zone 2 LEDs       | 24 Front Panel Display         | 30 Direction or Level Buttons |
| 8 VCR1 Button and LEDs  | 17 Infrared Emitter                |                                | 31 Recall Button              |

---

# Front Panel Description

See Figure 1 on page 7

## FEATURES

The Home Theater Standard 7.1 front panel provides power on and off; input, zone, and processing mode selection; monitoring and display of processor status; and balance and volume control. The front panel features are described below:

### Basic Operation Buttons

#### 1 Power Button

The power button switches the Home Theater Standard 7.1 from the stand-by to the operational mode.

---

#### Note

*When you power off while zone 2 is selected, only zone 2 turns off. Press the power button or HTS key a second time to power off the main zone.*

#### 2 Power LED

The blue power LED illuminates when the Home Theater Standard 7.1 is in the operational mode.

#### 3 Stand-by LED

The red stand-by LED illuminates when the back panel power switch (55) is on, indicating that the Home Theater Standard 7.1 is in the stand-by mode. Krell recommends that the back panel power switch remain on at all times.

#### 4 Infrared Sensor

The infrared sensor receives commands from the Home Theater Standard 7.1 remote control. For proper remote control operation, make sure the infrared sensor is not covered or obstructed.

### Device Selection Buttons and LEDs

The Home Theater Standard 7.1 is equipped with ten source selection buttons. If properly configured, the Home Theater Standard 7.1 automatically engages the correct video and audio inputs when you press the source selection button.

Above each button are two LEDs, one red and one green. The red LED illuminates when the input is engaged and playing in the main zone. The green LED illuminates when the input is engaged and playing in zone 2.

#### 5 DVD Button and LED

Use this button to select the digital videodisc device.

#### 6 LD Button and LED

Use this button to select the laser disc device.

#### 7 SAT Button and LED

Use this button to select the satellite feed device.

**Device Selection**  
**Buttons and LEDs, continued**

**8 VCR Button and LED**

Use this button to select the VCR device.

**9 TV Button and LED**

Use this button to select the television device.

**10 CD Button and LED**

Use this button to select the compact disc device.

**11 Tuner Button and LED**

Use this button to select the AM/FM tuner device.

**12 Aux1 Button and LED**

Use this button to select an auxiliary device, such as phono, tape, or an additional DVD, LD, CD, or VCR.

**13 Aux2 Button and LED**

Use this button to select a second auxiliary device, such as phono, tape, or an additional DVD, LD, CD, or VCR.

**14 Tape/VCR2 Button and LED**

Use this button to playback pre-recorded tapes. You may also use this button to compare the output signal of an analog tape recorder to an audio source. See ***Tape Input and Output***, on page 71.

**15 Main Zone and Zone 2 Button**

Use this button to select either main zone or zone 2 device control. This button also acts as a zone 2 power button when the main zone power is off. See ***Main Zone and Zone 2 Operation***, on page 72.

**16 Main Zone and Zone 2 LEDs**

The Home Theater Standard 7.1 has two zones for controlling sources: main zone and zone 2. Above each source selection button are two LEDs, one red and one green. The red LED illuminates when the input is engaged and the source is playing in the main zone. The green LED illuminates when the input is engaged and the source is playing in zone 2.

**17 Infrared Emitter**

Emits the Home Theater Standard 7.1 remote operation code to a learning remote. See ***Program Remote***, on page 64.

## Processing Mode Buttons and LEDs

### 18 Stereo Button and LED

Use this button to select stereo decoding, in order to make an A/B comparison or listen to a stereo recording in two channel format (left and right). The red LED illuminates when this feature is engaged.

After you select a mode, press the stereo button once. Press the stereo button again to make the A/B comparison. Press the stereo button again to exit stereo format.

---

#### Note

*You can make an A/B comparison when you press the stereo button, only if you have selected a previous mode.*

### 19 Mode 1 Button and LED

### 20 Mode 2 Button and LED

Use these buttons to select available processing modes (such as Dolby Digital, DTS, PLII Movie, THX, etc.) for incoming signals from a video or audio source.

The default mode for a signal is always stored in Mode 1. Use the Mode 1 button to select the default mode. All modes that can be used for the same signal are automatically stored in Mode 2. Use the Mode 2 button to scroll through these other modes. The last mode displayed in Mode 2 is the one selected. Based on the source signal, the Home Theater Standard 7.1 automatically selects the correct modes available for the signal.

### 21 Pro Logic II Button and LED

Use this button to select the Dolby Pro Logic II mode for Dolby Surround encoded material, including laser discs, videotapes, television broadcasts, and compact discs. The red LED illuminates when Dolby Pro Logic II decoding is selected.

---

#### Note

*This mode is selected automatically if Dolby Digital source material is encoded for Pro Logic. To turn off this mode, press the Pro Logic II button.*

### 22 Preamp Button and LED

Use this button to send the signal from an analog input directly to the volume control, with no digital processing, using the analog stage of the preamp. This avoids possible digital signal degradation and can be used for components such as the Krell KPS 28c Compact Disc Player that have a high quality signal. See **Assign Analog Audio Inputs**, on page 45, for information on assigning the analog input to one of the device buttons (DVD, LD, SAT, VCR, TV).

---

#### Note

*This feature is only available with a signal from an analog input. If you attempt to use it with a signal from a digital input, The Home Theater Standard 7.1 on-screen display will read NOT ALLOWED.*

**Processing Mode Buttons  
and LEDs, continued**

**23 THX Button**

Use this button to select one of the various THX modes available for the current signal.

**Display**

**24 Front Panel Display**

The front panel window provides status messages for Home Theater Standard 7.1 operations, including volume and balance level, decoding mode and zone information. In addition, when a new device is selected, the physical inputs are displayed. The display turns off after 60 seconds of inactivity.

**Individual Channel  
Trim Buttons**

Use the center, surr/back, and sub buttons to change taste trims (to make temporary speaker output adjustments) of +/- 10 dB. These temporary changes revert to 0 dB when a new device is selected or when the system is powered down. For more information on taste trims and master (programmable) trims, see **Configure Level Adjustment**, on page 49.

**25 Center Button**

Press the center button, then use the direction or level buttons (30) to adjust the center loudspeaker volume.

**26 Surr/Back Button**

Press the surr/back button, then use the direction or level buttons (30) to adjust the volume of the surround loudspeakers. To adjust the back loudspeakers, press the surr/back button. SURROUND TRIM appears on the front panel display. Press the surr/back button again. SURR/BACK appears on the front panel display. Then use the direction or level buttons to adjust the volume of the back loudspeakers.

**27 Sub Button**

Press the sub (subwoofer) button, then use the direction or level buttons (30) to adjust the subwoofer loudspeaker volume.

**28 Balance Button**

Press and hold this button to adjust the main left/right speaker balance. This button converts the volume level controls to balance controls.

Balance levels are shown numerically on the front panel display. Balance may be adjusted in .5 dB increments, up to 6 dB. The center position is displayed as BAL 0. The balance level buttons revert back to their original functions as volume level controls after 3 seconds of inactivity.

**Processor Function  
Buttons**

**29 Save Button**

Press and hold this button to save system configuration settings. The save button is also used in programming a learning remote. See ***Saving and Recalling Customized Settings and Restoring the Factory Default System Settings***, on page 70, and ***Program Remote***, on page 64.

**30 Direction or Level Buttons**

Use these buttons to scroll through menu selections, adjust the output for the entire system, and adjust balance and volume levels for the center loudspeaker, surround/back loudspeakers, and subwoofer. Volume and balance levels are shown in the front panel display (24).

**31 Recall Button**

Use this button to recall previously stored system configuration settings. Also use this button to return configuration settings to factory default: With the Home Theater Standard 7.1 in the operational mode, hold the recall button and press the power button. See ***Saving and Recalling Customized Settings and Restoring the Factory Default System Settings***, on page 70.



**Figure 2 The Home Theater Standard 7.1 Back Panel**

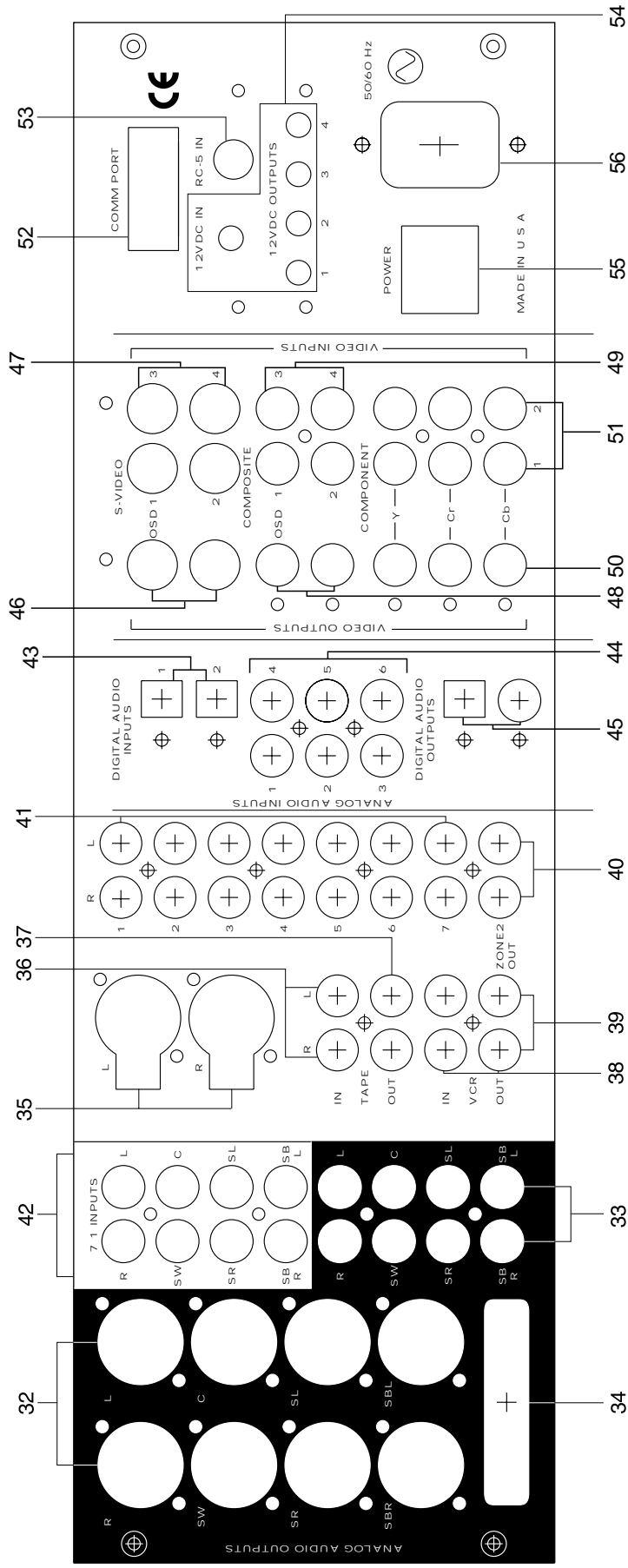

**Analog Audio Outputs and Inputs**

- 32 Balanced Analog Audio Outputs
- 33 Single-ended Analog Audio Outputs
- 34 Multichannel Audio Output Connector
- 35 Balanced Analog Audio Inputs
- 36 Tape In Left and Right
- 37 Tape Out Left and Right
- 38 VCR In Left and Right
- 39 VCR Out Left and Right

**Analog Audio Outputs and Inputs, continued**

- 40 Zone 2 Out Left and Right
- 41 Single-ended Analog Audio Inputs
- 42 7.1 Audio Inputs

**Digital Audio Inputs and Outputs**

- 43 EIA Optical Digital Audio Inputs
- 44 Coaxial Digital Audio Inputs
- 45 Digital Audio Outputs

**Video Inputs and Outputs**

- 46 S-video Outputs
- 47 S-video Inputs
- 48 Composite Video Outputs
- 49 Composite Video Inputs
- 50 Component Video Output
- 51 Component Video Inputs

**Back Panel Remote Control Connections**

- 52 Comm Port RS-232 Remote Connector
  - 53 RC-5 In
  - 54 12 VDC In and Out
- Power Connections**
- 55 Back Panel Power Switch
  - 56 IEC Connector

---

## Back Panel Description

See Figure 2 on page 13

### FEATURES

The back panel of the Home Theater Standard 7.1 provides all audio and video input and output connections, remote control inputs and outputs, power on and off, and power connection. The back panel functions are described below.

### Analog Audio Outputs and Inputs

#### **32 Balanced Analog Audio Outputs**

The Home Theater Standard 7.1 is equipped with eight balanced analog audio channel outputs, with XLR connectors, for the left, center, subwoofer, surround left, surround right, back left, and back right.

#### **33 Single-ended Analog Audio Outputs**

The Home Theater Standard 7.1 is equipped with eight single-ended analog audio channel outputs, with RCA connectors, for the left, center, right, subwoofer, surround left, surround right, back left, and back right.

#### **34 Multichannel Audio Output Connector**

The Home Theater Standard 7.1 is equipped with a multichannel audio output with a DB-25 connector, which contains the output connections for all the output channels (left, center, right, subwoofer, surround left, surround right, back left, and back right).

#### **35 Balanced Analog Audio Inputs**

The Home Theater Standard 7.1 is equipped with one set of balanced inputs with XLR connectors.

#### **36 Tape In Left and Right**

The Home Theater Standard 7.1 is equipped with one set of single-ended tape inputs with RCA connectors.

#### **37 Tape Out Left and Right**

The Home Theater Standard 7.1 is equipped with one set of single-ended tape outputs with RCA connectors.

#### **38 VCR In Left and Right**

The Home Theater Standard 7.1 is equipped with one set of single-ended inputs with RCA connectors, for a VCR audio source.

#### **39 VCR Out Left and Right**

The Home Theater Standard 7.1 is equipped with one set of single-ended outputs with RCA connectors, for a VCR audio source.

#### **40 Zone 2 Out Left and Right**

The Home Theater Standard 7.1 is equipped with one set of single-ended zone 2 outputs with RCA connectors.

#### **41 Single-ended Analog Audio Inputs**

The Home Theater Standard 7.1 is equipped with seven sets of single-ended inputs with RCA connectors.

**Analog Audio Outputs  
and Inputs, continued**

**42 7.1 Audio Inputs**

The Home Theater Standard 7.1 is equipped with eight single-ended 7.1 inputs for multichannel SACD and DVD audio devices. These inputs currently act as analog pass-through inputs, with no mode processing capabilities.

**Digital Audio Inputs  
and Outputs**

**43 Optical Digital Audio Inputs**

The Home Theater Standard 7.1 is equipped with two optical digital EIAJ inputs with TosLink connectors.

**44 Coaxial Digital Audio Inputs**

The Home Theater Standard 7.1 is equipped with six coaxial digital audio inputs with RCA connectors.

**45 Digital Audio Outputs**

The Home Theater Standard 7.1 is equipped with two digital audio outputs: one coaxial with an RCA connector, and one EIAJ optical with a TosLink connector.

**Video Inputs  
and Outputs**

**46 S-video Outputs**

The Home Theater Standard 7.1 is equipped with two S-video outputs with DIN connectors. The main S-video output (labeled OSD on back panel) includes on-screen display. For dubbing purposes, the second S-video output does not include on-screen display.

**47 S-video Inputs**

The Home Theater Standard 7.1 is equipped with four S-video inputs with DIN connectors.

**48 Composite Video Outputs**

The Home Theater Standard 7.1 is equipped with two composite video outputs with RCA connectors. The main composite video output (labeled OSD on back panel) includes on-screen display. For dubbing purposes, the second composite video output does not include on-screen display.

**49 Composite Video Inputs**

The Home Theater Standard 7.1 is equipped with four RCA composite video inputs with RCA connectors.

**50 Component Video Outputs**

The Home Theater Standard 7.1 is equipped with one set of component video outputs with RCA connectors. Component video uses three wires, labeled Y, Cr, and Cb on the back panel, to convey the video signal. These inputs are compatible with all wideband video sources. See **Configure Devices**, on page 40.

---

**Back Panel Description, continued**

**Video Inputs and Outputs,**  
*continued*

**51 Component Video Inputs**

The Home Theater Standard 7.1 is equipped with two sets of component video inputs.

---

**Note**

*On-screen display (OSD) is not available for progressive component video. OSD is available for interlaced component video.*

**Back Panel Remote  
Control Connections**

**52 Comm Port RS-232 Connector**

The Home Theater Standard 7.1 is equipped with an RS-232 communication port, which allows you to send operational instructions directly to the Home Theater Standard 7.1 using an external computer control system. For more information, see **RS-232 Port: Sending Commands and Interpreting Data**, the developer's reference for the Home Theater Standard 7.1.

---

**Note**

*The Home Theater Standard 7.1 has a PHAST Link option.*

**53 RC-5 In**

The RC-5 input makes custom installation easy and secure by accepting baseband RC-5 input commands from hardwired remote controllers.

**54 12 VDC In and Out**

The 12 VDC output sends a 12 Volt power on/off signal to other Krell components via a 12 V trigger cable, as well as to other devices that incorporate 12 Volt power on/off trigger input. The Home Theater Standard 7.1 has four programmable 12 Volt outputs: Out1, Out2, Out3, and Out4; and one input.

---

**Note**

*When the Home Theater Standard 7.1 is in the operational mode and a trigger is configured, the 12 VDC Out provides 12 V of DC output. When the Home Theater Standard 7.1 is in the stand-by mode or off, or if a trigger is not configured, the DC output is 0 V.*

**Power Connections**

**55 Back Panel Power Switch**

Use this switch to change the Home Theater Standard 7.1 from off to stand-by.

**56 IEC Connector**

The Home Theater Standard 7.1 is equipped with a standard female IEC power connector, for use with the AC power cord.

**Figure 3 The Home Theater Standard 7.1 Remote Control**

**Power Keys**

- 57 Amp Key
- 58 Pre Key (Power Pre Key)

**Zone Selection Keys**

- 59 Main Key
- 60 Z2 Key

**Device Selection Keys**

- 61 DVD Key
- 62 LD Key
- 63 SAT Key
- 64 TV Key
- 65 CD Key
- 66 Tuner Key
- 67 Aux1 Key
- 68 Aux2 Key
- 69 VCR Key
- 70 Tape Key

**Processing Mode Keys**

- 71 Stereo Key
- 72 M1 Key (Mode 1 Key)
- 73 M2 Key (Mode 2 Key)
- 74 ProLogic II Key
- 75 Pre Key (Preamp Pre Key)

**Control Function Keys**

- 76 Bal Key (Balance Key)
- 77 Cntr Key
- 78 Surr/Back Key
- 79 Sub Key
- 80 Prev Key
- 81 Direction or Level Keys
- 82 Menu Key
- 83 Mute Key
- 84 Enter Key
- 85 THX Key

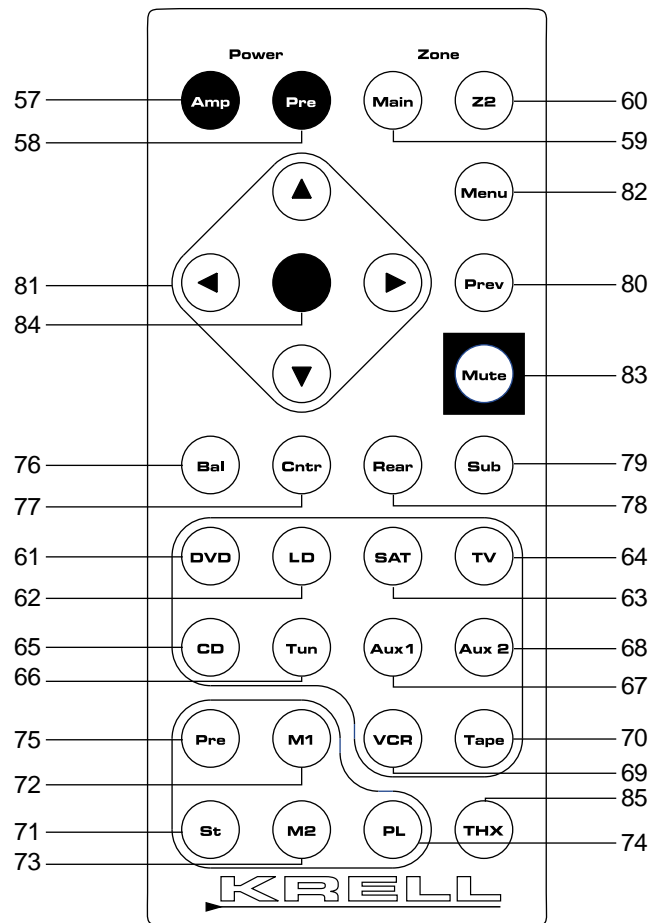

---

# Remote Control Description

See Figure 3 on page 17

The Home Theater Standard 7.1 remote control provides on and off, input selection, processing mode selection, speaker volume and balance adjust, and mute functions, as well as access to the system configuration menu.

To send operational instructions directly to the Home Theater Standard 7.1 using an RS-232-based external computer control system, see **RS-232 Port: Sending Commands and Interpreting Data**, the developer's reference for the Home Theater Standard 7.1.

## BATTERY INSTALLATION AND REMOVAL

The Home Theater Standard 7.1 remote control uses one CR2025 lithium battery, which is included with the shipment.

To open the battery compartment on the back of the remote control:

1. Place the remote face down on the table.
2. Use your thumbnail or a small jeweler's or eyeglass screwdriver to move the small tab toward the center of the remote, while using your index fingernail or screwdriver to pull down gently on the slot to the right of the tab. The battery compartment will slide out.
3. Place the battery, plus side up, in the battery tray.
4. Slide battery compartment back into the remote until you hear a click.

The remote control is ready for operation.

---

### Notes

*Do not use a knife or other sharp objects to open the battery compartment; they will scratch the remote control finish.*

*Replace batteries when remote control function becomes intermittent.*

*Remove batteries if the remote control is not to be used for a long period of time. Battery leakage can damage the remote control.*

## FEATURES

Home Theater Standard 7.1 remote control keys and their functions are described below:

### Power Keys

#### **57 Amp Key**

Use this key to power on/off a Krell remote control amplifier.

#### **58 Pre Key (Power Pre Key)**

Use this key to switch the Home Theater Standard 7.1 between the stand-by mode and the operational mode.

---

### Note

*When you power off while zone 2 is selected, only zone 2 turns off. Press the power button or the power pre key a second time to power off the main zone.*

**Zone Selection Keys**

**59 Main Key**

Use this key to select the main zone for a device.

**60 Z2 Key**

Use this key to select zone 2 for a device.

---

**Note**

*The main zone is the factory default. To activate a device in zone 2, press the remote control Z2 key (60) before selecting the device. For other main zone and zone 2 operating options, see **Main Zone and Zone 2 Operation**, on page 72.*

**Device Selection Keys**

**61 DVD Key**

Use this key to select the digital videodisc device.

**62 LD Key**

Use this key to select the laser disc device.

**63 SAT Key**

Use this key to select the satellite source device.

**64 TV Key**

Use this key to select the television device.

**65 CD Key**

Use this key to select the compact disc device.

**66 Tuner Key**

Use this key to select the AM/FM tuner device.

**67 Aux1 Key**

Use this key to select the auxiliary device, such as phono, tape, or an additional DVD, LD, CD, or VCR.

**68 Aux2 Key**

Use this key to select a second auxiliary input, such as phono, tape, or an additional DVD, LD, CD, or VCR.

**69 VCR Key**

Use this key to select the VCR device.

**70 Tape Key**

Use this key to select the output from an analog tape recorder connected to the tape inputs.

---

**Note**

*Once a device is selected, press and hold the device selection key for three seconds to change the tape output source bus to the zone currently selected. See **Tape Input and Output**, on page 71.*

## **Processing Mode Keys**

### **71 Stereo Key**

Use this key to select stereo decoding, which allows you to make an A/B comparison or listen to a stereo recording in two channel format (left and right). The red LED illuminates when this feature is engaged.

After you select a mode, press the stereo button once. Press the stereo button again to make the A/B comparison. Press the stereo button again to exit stereo format.

---

#### **Note**

*You can make an A/B comparison when you press the stereo button, only if you have selected a previous mode.*

### **72 M1 Key (Mode 1 Key)**

### **73 M2 Key (Mode 2 Key)**

Use these keys to select available processing modes (such as Dolby Digital, DTS, PLII Movie, THX, etc.) for incoming signals from a video or audio source.

The default mode for a signal is always stored in Mode 1. Use the Mode 1 key to select the default mode. All other modes that can be used for the same signal are automatically stored in Mode 2. Use the Mode 2 key to scroll through these other modes. The last mode displayed in Mode 2 is the one selected. Based on the source signal, the Home Theater Standard 7.1 automatically selects the correct modes available for the signal.

### **74 Pro Logic II Key**

Use this button to select the available Dolby Pro Logic II modes for Dolby Surround encoded material, including laser discs, videotapes, television broadcasts, and compact discs. The red LED illuminates when the Home Theater Standard 7.1 is in the Dolby Pro Logic II decoding mode.

---

#### **Note**

*This mode is selected automatically if Dolby Digital source material is encoded for Pro Logic. To turn off this mode, press the Pro Logic II key.*

### **75 Pre Key (Preamp Pre Key)**

Use this button to send the signal from the analog input directly to the volume control, with no digital processing, using the analog stage of the preamp. This avoids possible digital signal degradation and can be used for components such as the KPS 28c that have a high quality signal. See **Assign Analog Audio Inputs**, on page 45, for information on assigning the analog input to one of the device buttons (DVD, LD, SAT, VCR, TV).

---

#### **Note**

*This feature is only available with a signal from an analog input. If you attempt to use it with a signal from a digital input, the Home Theater Standard 7.1 on-screen display will read NOT ALLOWED.*



## Control Function Keys

### 76 Bal Key (Balance Key)

Press and hold this key to convert the volume level controls to balance controls. See **Balance Button (28)**, on page 11.

---

### Note

Use the center, surr/back, and sub keys to change taste trims to make temporary loudspeaker output adjustments of +/- 10 dB. These changes revert to 0 dB when a new source is selected or the system is powered down. See **Configure Level Adjustment**, on page 49.

### 77 Cntr Key

Use this key to select the center loudspeaker, then use the direction keys (81) to adjust volume.

### 78 Surr/Back Key

Use this key to select the surround and/or back loudspeakers, then use the direction keys (81) to adjust the volume of the surround loudspeakers. To adjust the back loudspeakers, press the surr/back button. SURROUND TRIM appears on the front panel display (24). Press the surr/back button again. SURR/BACK appears on the front panel display. Then use the direction keys to adjust the volume of the back loudspeakers.

### 79 Sub Key

Use this key to select the subwoofer, then use the direction keys (81) to adjust volume.

### 80 Prev Key

Use this key to escape from a system configuration on-screen menu to the previously displayed screen.

### 81 Direction or Level Keys

Use these keys to scroll through menu selections, adjust the output for the entire system, and adjust balance and volume levels for the center loudspeaker, surround/back loudspeakers, and subwoofer. Volume and balance levels are shown in the front panel display (24).

### 82 Menu Key

Use this key to access the system configuration on-screen menus.

### 83 Mute Key

Use this key to mute the output of the Home Theater Standard 7.1. VOLUME MUTE appears in the front panel display (24).

### 84 Enter Key

Use this key to accept configuration menu selections, accept an input device selection, or to display current system conditions.

### 85 THX Key

Use this key to select one of the THX modes available for the current signal.

---

# Connecting the Home Theater Standard 7.1 to Your System

This section provides information about connecting the Home Theater Standard 7.1 to your system. To expedite setup, please review **Getting Started**, on page 6, before following the connection steps below.

## CONNECTION STEPS

### Step 1: Power Off and Prepare Wiring

Follow these steps to connect the Home Theater Standard 7.1 to your system:

1. Make sure all power sources and components are off before connecting inputs and outputs.
2. Neatly arrange and organize wiring to and from the Home Theater Standard 7.1 and all components. Separate AC wires from audio cables to prevent hum or other unwanted noise from being introduced into the system.

### Step 2: Connect Analog Sources

The Home Theater Standard 7.1 is equipped with balanced, single-ended inputs, and 7.1 inputs.

Krell recommends using balanced interconnect cables. Balanced interconnect cables not only can minimize sonic loss but also are immune to induced noise, especially for installations using long cables. Balanced connections have 6 dB more gain than single-ended connections. When level matching is critical, keep this specification in mind. Krell recommends that you use balanced inputs for components that will use the preamp mode.

For stereo analog input sources, connect the right and left outputs of your source components to the inputs on the Home Theater Standard 7.1. The Home Theater Standard 7.1 is equipped with nine sets of single-ended analog audio inputs (41) (S-1 through S-7, tape, and VCR) via RCA connectors and one set of balanced analog audio inputs (35) via XLR connectors.

For multichannel analog sources (for example, multichannel SACD and DVD audio players), connect the outputs of your source component to the 7.1 inputs (42) on the back panel.

---

**Connecting the Home Theater Standard 7.1  
to Your System, continued**

**Step 3: Connect  
Digital Sources**

The Home Theater Standard 7.1 is equipped with six coaxial digital audio inputs (44) via RCA connectors and two digital EIAJ optical inputs (43) via TosLink connectors. Connect the digital audio output of your source components to the digital inputs on the Home Theater Standard 7.1.

---

**Note**

*For sources that are equipped with both digital and analog outputs, the digital outputs should be connected for listening in the main zone; the analog outputs should be connected for listening in zone 2 and for recording from the main zone or zone 2.*

**Please read  
before continuing  
on to Step 4**

1. The Home Theater Standard 7.1 will only operate correctly:
  - When the video source signal (component, s-video, or composite) to the Home Theater Standard 7.1 and the video signal from the Home Theater Standard 7.1 to the video monitor match, and
  - When the video device is configured for that same signal (component, s-video, or composite) in the Home Theater Standard 7.1 configuration menu.
2. If you select the video signal that is the factory default for the video device (for example: a component signal for the DVD), you do not need to configure the video signal in the Home Theater Standard 7.1 configuration menu. See **Figure 4**, for *North American operation, on page 25*, and **Figure 5**, for *overseas operation, on page 26*.
3. If you are not using the default video signal, you must use the configuration menu in the Home Theater Standard 7.1 and change the video signal for the video device.
4. You need the remote control and the on screen display (OSD) to access the configuration menu.
5. In order for the OSD to be visible:
  - Set your monitor to NTSC Interlaced for North American operation,  
or
  - Set your monitor to PAL Interlaced or NTSC Interlaced for overseas operation.

When your monitor is set to NTSC Progressive or PAL Progressive, the OSD will not be visible.
6. The video device LED must be illuminated on the front panel of the Home Theater Standard 7.1 in order for the OSD to be visible.

**Step 4: Match Video  
Formats and Signals**

To match the video formats and signals in your system, we recommend that you follow these steps:

1. Determine your monitor format. The factory default video format in North America is NTSC Interlaced. The factory default video format overseas is either NTSC Interlaced or PAL Interlaced.
2. Look at the back panel of the video source, to determine which video signals you have available. Video signals can be component (best fidelity), composite, or s-video. For a description of video signals, see **Choosing a Standard Video Signal**, on page 27.
3. Review **Figure 4**, on page 25, if you are located in North America, and **Figure 5**, on page 26, if you are located overseas. These figures show the factory default video signals and formats, by video device. If you do not want to use the factory defaults, you need to select the signal (component, s-video, or composite) and format (NTSC or PAL) you want to use via the Home Theater Standard 7.1 configuration menu.
4. Select the video signal you want to use for each video device.

**Connecting the Home Theater Standard 7.1  
to Your System, continued**

**Step 4: Match Video Formats  
and Signals, continued**

**Figure 4 Device Selection Buttons, Factory Default Video Signals, and Video Formats for the Home Theater Standard 7.1, North American Operation**

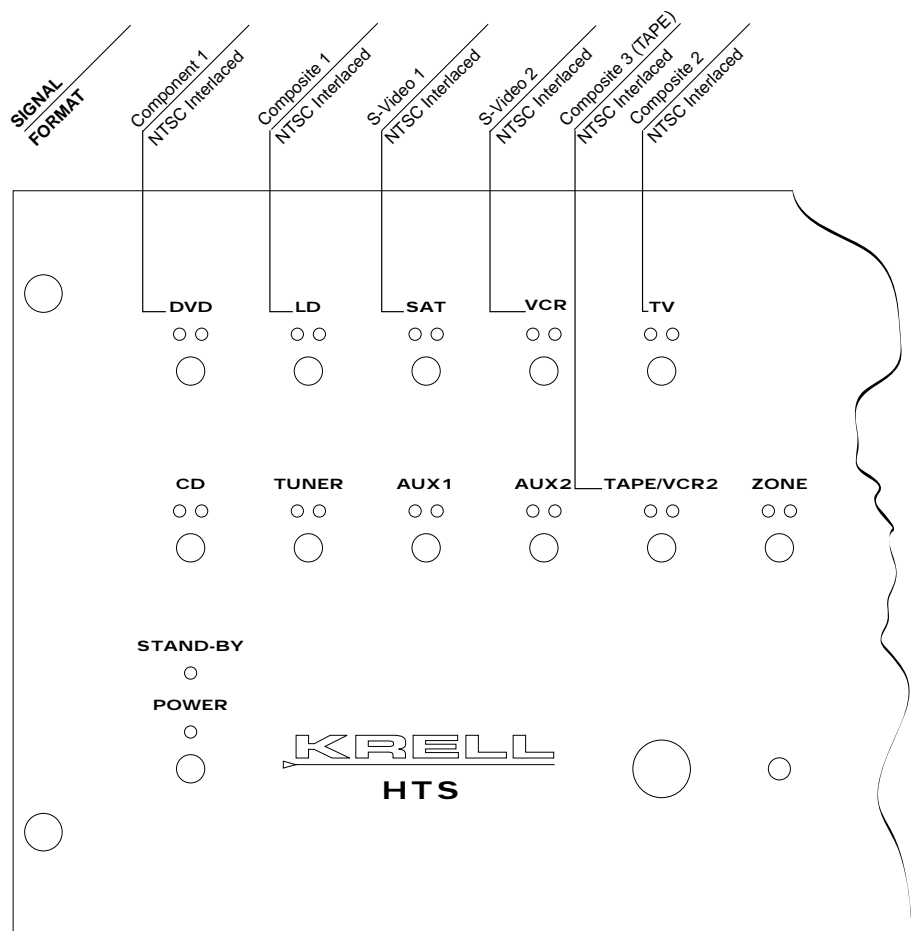

**Note**  
For CD, TUNER, AUX 1,  
and AUX 2, the factory  
video defaults are disabled  
and therefore a video  
format is not available.

**Connecting the Home Theater Standard 7.1  
to Your System, continued**

**Step 4: Match Video Formats  
and Signals, continued**

**Figure 5 Device Selection Buttons, Factory Default Video  
Signals, and Video Formats for the Home Theater Standard 7.1,  
International Operation**

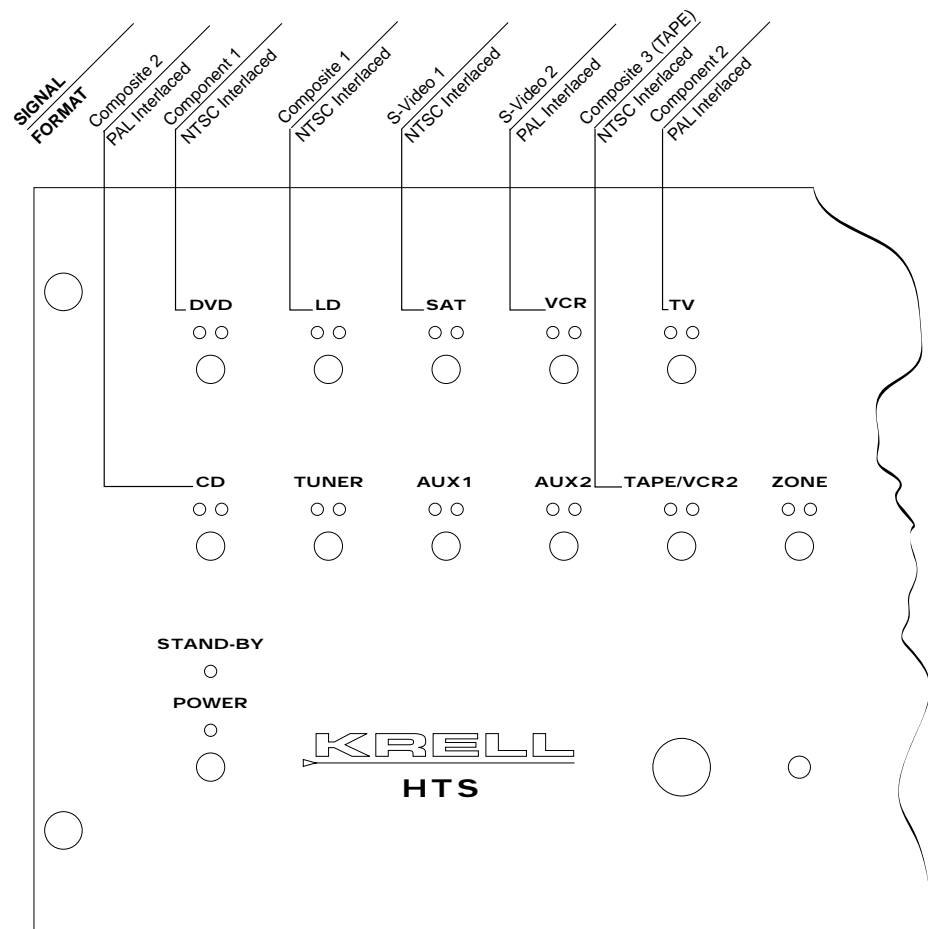

**Note**  
For TUNER, AUX 1, and  
AUX 2, the factory video  
defaults are disabled and  
therefore a video format  
is not available.

**Step 5: Connect  
Video Sources and  
the Video Monitor**

The Home Theater Standard 7.1 is equipped with component, s-video, and composite connections. We recommend that you use the component connection to the Home Theater Standard 7.1, wherever the video source and video monitor both feature component connections. See the user manuals included with these sources for more information.

Video inputs for the Home Theater Standard 7.1 include 2 component inputs (51), 4 s-video inputs (47), and 4 composite inputs (49). Video outputs include 1 component video output (50), 2 s-video outputs (46), and 2 composite video outputs (48). The component video output, 1 s-video output, and 1 composite video output include on-screen display (OSD). For dubbing purposes, only the s-video and composite outputs labeled OSD display on screen information.

---

**CHOOSING A STANDARD VIDEO SIGNAL**

There are three standard video signals:

1. **Component Video.** Choose the component connection for video monitors that have component (YPbPr or YCbCr) connections. Component video is the most accurate standard video signal, using three wires to convey luminance (Y), red minus luminance (R-Y), and blue minus luminance (B-Y) signals. These signals bypass television circuitry required to process s-video signals, eliminating cross-color contamination and resulting in more reliable, correct color.

**Interlaced signals** build screen content in two passes.

**Progressive signals** build screen content in one pass. This technology eliminates motion artifacts and produces film-quality pictures. Both your source and video monitor must be equipped with progressive video technology to realize this advantage.

2. **S-Video.** Choose the s-video connection for video monitors that have s-video connections but do not have component connections. S-video separately transmits the luminance (Y) and color (C) components of the video signal using one wire. The s-video signals bypass television circuitry required by composite video, and reduces video noise as well as cross-contamination of color and black and white signals.
3. **Composite Video.** Choose the composite connection for video monitors that are not equipped with component video or s-video. Composite video is an encoded video signal that transmits luminance (Y) and color (C) information on one wire.

---

## Connecting the Home Theater Standard 7.1 to Your System, *continued*

### **Step 5: Connect Video Sources and the Video Monitor, *continued***

Follow these steps to connect the Home Theater Standard 7.1 to the video sources and monitor in your system:

1. Connect the video outputs on each video source in your system to video inputs on the Home Theater Standard 7.1.
2. Connect the video outputs on the Home Theater Standard 7.1 labeled OSD to the inputs of the video monitor.

### **Step 6: Activating the On Screen Display (OSD)**

The on screen display (OSD) needs to be active in order to access the Home Theater Standard 7.1 configuration menu.

1. Power on the Home Theater Standard 7.1 by switching the back panel power switch to on. Wait for the Home Theater Standard 7.1 to initialize. The words PLEASE WAIT, INITIALIZING appear in the front panel display (24), followed by the appearance of the model name, the software version, and the AC line frequency in the display window. After a short period of time, the front panel display becomes blank.
2. Then press the power button (1) on the front panel or the power pre key (58) on the remote control to power on the Home Theater Standard 7.1. The Home Theater Standard 7.1 defaults to the DVD device which is configured with the following factory defaults: video signal=component; format=NTSC Interlaced.
3. Select the video device that matches the video connection from the Home Theater Standard 7.1 to the video monitor. See **Figure 4**, on page 25, for North American operation or **Figure 5**, on page 26, for International operation.
4. Press the device selection button on the front of the Home Theater Standard 7.1, or use the remote control key dedicated to the video device. The device selection LED on the front panel of the Home Theater Standard 7.1 illuminates.
5. Press the menu key (82) on the remote control to verify that the OSD appears on the video monitor. The words MENU MODE appear on the front panel display and the configuration menu screen is visible on the video monitor.

If the video signals do not match, and you press the menu key on the remote control, the words MENU MODE appear in the front panel display and a blank screen remains on your video monitor.



---

## Connecting the Home Theater Standard 7.1 to Your System, *continued*

### Step 6: Activating the On Screen Display (OSD), *continued*

#### Troubleshooting the OSD

Follow these troubleshooting steps, if the OSD is not visible after you follow the above activation steps 1 through 5:

1. Check the AC connections and the video source and monitor connections to the Home Theater Standard 7.1
2. Match the video format and signal. (For example, component to component and NTSC to NTSC.)
3. Switch the monitor from Progressive to Interlaced.
4. Make sure the selected device (device LED illuminated) has a factory default signal that matches the connection from the Home Theater Standard 7.1 to the video monitor.
5. Press the enter key (84) on the remote control, to verify the video signal for a device and to view the current video configuration on the front panel display.

#### Video Source Connection Scenarios

#### **EXAMPLE 1: You want to use a component signal with a DVD device and you reside in North America.**

Connect the DVD device to the Home Theater Standard 7.1 and connect the Home Theater Standard 7.1 to the NTSC Interlaced video monitor using component connections. Since Figure 4 shows that the factory default for the DVD is component, you do not need to change the signal in the configuration menu.

#### **EXAMPLE 2: You want to use a component connection with a satellite source, and you reside in North America.**

Connect the satellite device to the Home Theater Standard 7.1 and connect the Home Theater Standard 7.1 to the NTSC Interlaced video monitor using component connections. Since Figure 4 shows that the factory default for the satellite device is s-video, you need to change the s-video signal to component in the configuration menu.

The DVD device factory default signal is component. To change the satellite device signal to component, first activate the DVD device by pressing the DVD button (5) on the front panel or the DVD key (61) on the remote control. The DVD device LED illuminates. Access the configuration menu of the Home Theater Standard 7.1 via the remote control menu key (82) and navigate to the CONFIGURE DEVICES menu screen. Select CONFIGURE VIDEO and go to the ASSIGN VIDEO INPUT screen. Select the satellite device and change the satellite signal from s-video to component.

---

**Connecting the Home Theater Standard 7.1  
to Your System, continued**

**Step 6: Activating the On  
Screen Display (OSD),  
continued**

**Video Source Connection  
Scenarios, continued**

**EXAMPLE 3: You want to use an s-video connection with a  
VCR device and you reside in Europe.**

Connect the VCR device to the Home Theater Standard 7.1 and connect the Home Theater Standard 7.1 to the PAL Interlaced video monitor using s-video (OSD) connections. Since Figure 5 shows that the factory default for the VCR is s-video, you do not need to change the signal in the configuration menu.

**EXAMPLE 4: You want to use an s-video connection with a  
satellite device using a PAL monitor. You reside in Europe.**

Connect the satellite device to the Home Theater Standard 7.1 and connect the Home Theater Standard 7.1 to the PAL monitor using s-video (OSD) connections. The satellite device factory default signal is s-video 1/NTSC Interlaced. See **Figure 5**.

The VCR device factory default signal is s-video 2 and the factory default format for the VCR is PAL. See **Figure 5**. To change the satellite device signal and monitor format, first activate the VCR device by pressing the VCR button (8) on the front panel or the VCR key (69) on the remote control. The VCR device LED illuminates. Access the configuration menu of the Home Theater Standard 7.1 via the remote control menu key (82) and navigate to the CONFIGURE DEVICES menu screen. Select CONFIGURE VIDEO and go to the ASSIGN VIDEO INPUT screen. Select the satellite device, change the satellite signal to S-VIDEO 2, and change the satellite format to PAL.

---

**Connecting the Home Theater Standard 7.1  
to Your System, continued**

**Step 7: Connect  
Amplifiers and  
Loudspeakers**

The Home Theater Standard 7.1 has balanced outputs with XLR connectors, single-ended outputs with RCA connectors, and is equipped with a DB-25 multichannel output. These output formats are active at all times, allowing simultaneous connection to separate amplifiers. Use only one output format per amplifier.

---

**IMPORTANT**

***Make sure that all sources are off when you configure the Home Theater Standard 7.1.***

1. Connect the outputs of the Home Theater Standard 7.1 to the input(s) of your power amplifier(s).

Use the DB-25 connector to connect to a DB-25-equipped amplifier:

Connect the DB-25 output on the Home Theater Standard 7.1 to the DB-25 multichannel input on the back panel of your amplifier. The DB-25 cable simultaneously transmits audio outputs and Trigger 1 signals from the DB-25 output of the Home Theater Standard 7.1 to all inputs and to a 5 VDC (5 Volt trigger) via the DB-25 input device.

---

**Note**

*If you are connecting the Home Theater Standard 7.1 to an amplifier via a DB-25 connector, you need to configure Trigger 1 on the Home Theater Standard 7.1 to send a 5 Volt trigger signal before operating the amplifier.*

2. Connect the power amplifiers to the loudspeakers.
3. Connect the AC power cord to the IEC connector (56) on the Home Theater Standard 7.1 and to the AC wall outlet.
4. Move the back panel power switch (55) into the up (on) position. The red power LED on the front panel illuminates. The words PLEASE WAIT, INITIALIZING appear in the front panel display (24). When the initializing message disappears, the Home Theater Standard 7.1 is ready to switch to the operational mode.
5. Use either the front panel power button (1) or the remote control power pre key (58) to power on the Home Theater Standard 7.1. The blue power LED (2) on the front panel illuminates. The Home Theater Standard 7.1 is now in the operational mode and ready to be configured.

---

# Overview: System Configuration and Navigation

This section briefly outlines the configuration menus and introduces the navigational features of the menus. To expedite setup, connect your entire system before configuring the Home Theater Standard 7.1. Match video signals and activate the on screen display (OSD) before attempting to access the configuration menu. See ***Connecting the Home Theater Standard 7.1 to Your System***, on page 22.

---

## **IMPORTANT**

***Make sure that all sources are off when you configure the Home Theater Standard 7.1.***

## **CONFIGURATION STEPS**

The easy-to-follow, step-by-step configuration menus let you set up your Home Theater Standard 7.1 for optimum performance. Detailed instructions begin on page 32. Krell recommends that you configure your component in the following order:

**For best results, follow these steps**

### **1. CONFIGURE SPEAKERS**

The configure speaker menu lets you tell the Home Theater Standard 7.1 how many and what type of loudspeakers are in your system and allows you to select the bass range for each loudspeaker. It also allows you to control the subwoofer output and set the crossover frequency.

### **2. LISTENING ROOM SETUP**

The listening room setup menu lets you define the exact location of each loudspeaker in the system, so that the Home Theater Standard 7.1 can synchronize the output to all speakers, no matter where they are located in the room.

### **3. CALIBRATE VOLUME**

The calibrate volume menu lets you match the inputs of different loudspeakers and amplifiers in your system.

### **4. CONFIGURE DEVICES**

The configure devices menu lets you assign each device's inputs and configure modes and triggers.

### **5. CONFIGURE LEVEL ADJUSTMENT**

The configure level menu lets you set master volume trims for the components in your system. These fixed positive or negative volume offsets let you maintain level matching while switching between inputs with different output levels.

### **6. OPERATION**

The operation menu lets you select screen background color, position and display time for on-screen display, set audio operation, program a learning remote control, and adjust frequency response using the Krell Digital Room Equalizer.

## **NAVIGATION CONVENTIONS**

The remote control is the main input device for configuring the Home Theater Standard 7.1. For all system options, use the following keys to navigate through the configuration menu screens:

### **82 Menu Key**

Press once to enter the configuration menu. The front panel display reads MENU MODE. The MAIN MENU screen appears. The HTS 7.1 reverts to the operational mode.

Press this key again to exit the configuration menu.

### **81 Direction or Level Keys**

Press to scroll line by line through options on a menu screen.

After pressing enter (84), press the direction or level key again to scroll through options within a single line.

### **84 Enter Key**

Press once to select a highlighted item. Once an item is selected, use the direction or level keys to scroll through available options within a line. To select a highlighted option within a line, press the enter key again.

### **80 Prev Key (Previous Key)**

Press once to return to the previous screen within the menu program.

## **To Select and Enter Menu Items**

When a menu screen first appears, and there is a cursor blinking at one menu item, press the enter key (84) to select the menu item. If the item is configurable, the entire selected menu item blinks along with the cursor.

Then use the direction keys (81) to configure the menu item you have selected: scroll through the options that are blinking. Press the enter key to set the selection you want. After you have set the selection you want, it stops blinking and only the cursor at the menu item is blinking. Use the direction keys to move the cursor that is blinking to the next menu item.

---

# System Configuration

The Home Theater Standard 7.1 is shipped with factory default selections in the configuration menus. For maximum performance, the Home Theater Standard needs to be configured for each system device, its capabilities, and loudspeaker positions in the listening room.

To save your new configuration menus, or revert to the factory defaults, see ***Saving and Recalling Customized Settings, and Restoring the Factory System Settings***, on page 70.

Krell recommends configuring your system step-by-step, in the sequential order described below. Enter information into the Home Theater Standard 7.1 through the interactive on-screen menus. These menus are structured to guide you through the setup process for each device, or for your entire surround sound system.

---

## **IMPORTANT**

***Make sure that any source devices are off when you configure the Home Theater Standard 7.1.***

## **ACCESSING THE MAIN MENU**

Press the menu key. The front panel display reads MENU MODE. The MAIN MENU screen appears with the cursor blinking at CONFIGURE SPEAKERS.

### **Main Menu Screen**

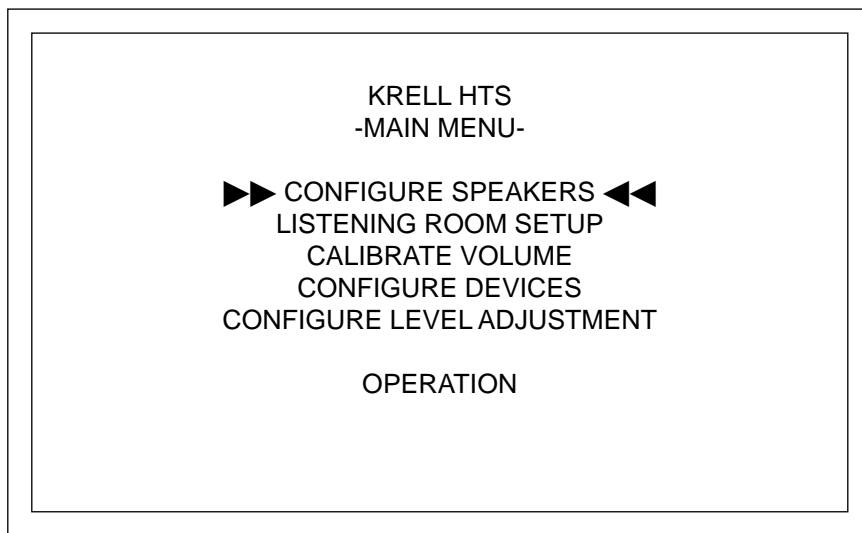

### **How To Navigate the Menu and Make a Selection**

1. Use the direction keys to scroll from line to line.
2. Press enter to select a line.
3. Use the direction keys to scroll through options within a line.
4. Press enter to select and set an option.
5. Use the direction keys to scroll to the next line.

**STEP 1  
CONFIGURE  
LOUDSPEAKERS**

The first option on the main menu screen, CONFIGURE SPEAKERS, lets you tell the Home Theater Standard 7.1 how many and what type of loudspeakers are in your system and select the bass range for each loudspeaker. It also allows you to control the subwoofer output and set the crossover frequency.

Select CONFIGURE SPEAKERS on the MAIN MENU. The SPEAKER SETUP screen appears:

**Speaker Setup Screen**

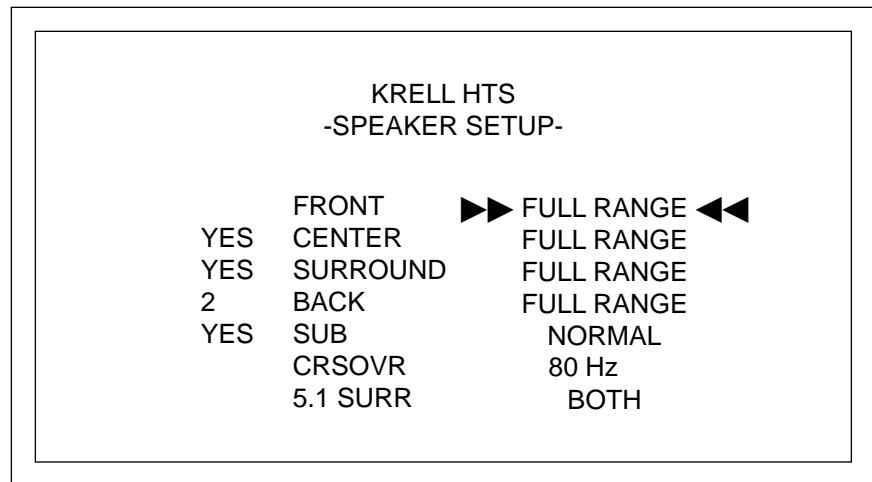

If you have a 5.1 system, select NO back speakers. If you have a 6.1 system, select 1 back speaker. If you have a 7.1 system, select 2 back speakers.

---

**Note**

*When 1 back speaker is selected, the signal is present at the left back output.*

---

## System Configuration, continued

### Speaker Setup Screen, continued

Using this screen, you can enable loudspeakers that are in your system in the left column and select loudspeaker characteristics in the far right column.

#### FULL RANGE

FULL RANGE sends 20Hz to 20KHz signals to the loudspeaker. LIMITED sends information from the crossover frequency (see below) to 20KHz to the loudspeaker. The frequencies below the crossover frequency are sent to the subwoofer if present; otherwise, these low frequencies are sent to the full range loudspeakers in the system.

#### SUB

Select NORMAL or ENHANCED to choose the amount of bass information sent to the subwoofer. NORMAL sends the low frequencies from the limited speakers and the .1 (or LFE) signal to the subwoofer.

ENHANCED sends additional bass information from the left and right loudspeakers to the subwoofer in addition to the low frequencies from the limited loudspeakers and the .1 (or LFE) signal.

#### CRSOVR

Crossover selections are 120, 100, 80, 60, and 40 Hz. The standard crossover setting is 80 Hz. Choose the crossover frequency appropriate for your loudspeakers. The frequencies below the crossover frequency are sent to the subwoofer if a subwoofer is present; otherwise, these low frequencies are sent to the full range loudspeakers in the system.

#### 5.1 SURR

Select SURROUND, BACK, or BOTH to choose which loudspeakers in a 6.1 or 7.1 system receive surround information when playing a Dolby Digital 5.1 or DTS 5.1 encoded software. SURROUND sends surround channel information to your surround loudspeakers only. BACK sends surround channel information to your back loudspeakers only. BOTH sends surround channel information to your surround and back loudspeakers simultaneously.

After selecting the appropriate loudspeaker setups for your system, press the previous key twice to return to the main menu.

### How To Navigate the Menu and Make a Selection

1. Use the direction keys to scroll from line to line.
2. Press enter to select a line.
3. Use the direction keys to scroll through options within a line.
4. Press enter to select and set an option.
5. Use the direction keys to scroll to the next line.



**STEP 2**  
**LISTENING ROOM**  
**SETUP**

The second option on the main menu screen, ROOM SETUP, allows you to tell the Home Theater Standard 7.1 the exact location of each loudspeaker in your system.

Select LISTENING ROOM SETUP on the MAIN MENU. The ROOM SETUP screen appears, with the cursor blinking at LEFT.

**Room Setup Screen**

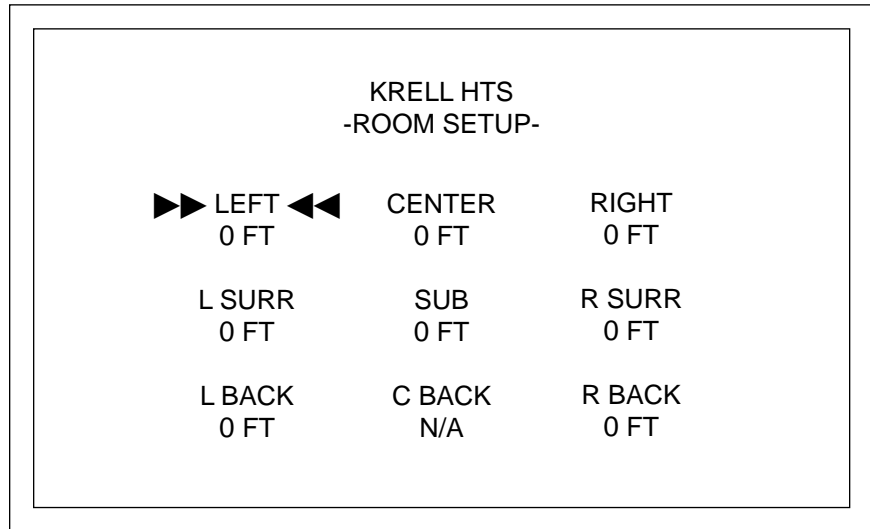

When you access the ROOM SETUP screen, the cursor is blinking at the LEFT loudspeaker. Use the direction and enter keys to navigate the screen, select loudspeakers, and enter the correct distance (0 to 30 feet) from the main listening position to the loudspeaker. After all the distances are set, press the previous key twice to return to the main menu.

---

**Note**

*Any speaker not configured in the SPEAKER SETUP menu displays N/A (not available) on the ROOM SETUP screen.*

### STEP 3 CALIBRATE VOLUME

The third option on the main menu screen, CALIBRATE VOLUME, allows you to calibrate each channel using the internal noise generator of the Home Theater Standard 7.1, either automatically, manually, or by listening to external program material.

**Note**

*A sound pressure level (SPL) meter is required for this procedure.*

Select CALIBRATE VOLUME on the MAIN MENU. The CALIBRATE ROOM SETUP screen appears, with the cursor blinking at AUTO NOISE SEQUENCE.

#### Calibrate Room Setup Screen

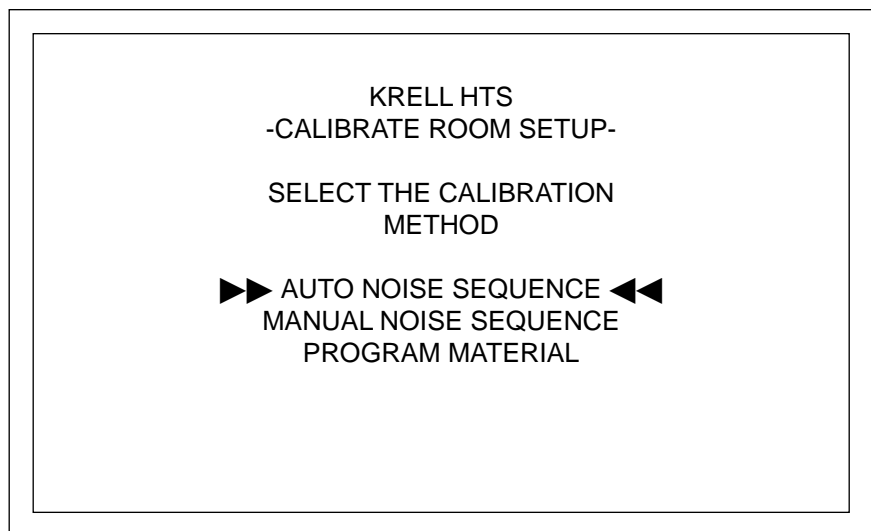

#### Auto Noise Sequence

Press the enter key to choose AUTO NOISE SEQUENCE. The AUTO CALIBRATION screen appears, with the cursor blinking at the left loud-speaker sound level.

#### Auto Calibration Screen

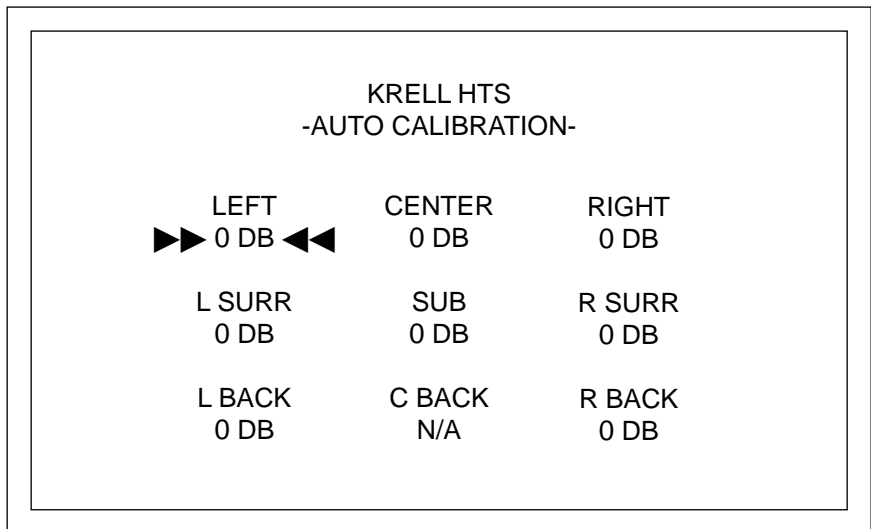

#### How To Navigate the Menu and Make a Selection

1. Use the direction keys to scroll from line to line.
2. Press enter to select a line.
3. Use the direction keys to scroll through options within a line.
4. Press enter to select and set an option.
5. Use the direction keys to scroll to the next line.

Set the SPL meter to C weighting and slow response. After initializing, the LEFT channel dB setting on the screen blinks, and you hear band limited white noise through the left loudspeaker. This noise continues for two seconds and then moves clockwise to the next loudspeaker in the system.

While the individual channel on screen is blinking, use the direction keys to adjust each loudspeaker's setting until the SPL meter reads 75 dB.

Repeat this process with the remaining loudspeakers. When all the loudspeakers are adjusted, press the previous key twice to return to the main menu screen.

---

**Note** *The adjustments must be made while the channel on screen is blinking.*

**Manual Noise Sequence** Press the enter key to choose MANUAL NOISE SEQUENCE. The manual noise sequence screen appears.

Set the SPL meter to C weighting and slow response. After initializing, the LEFT channel dB setting on the screen blinks, and you hear banded white noise through the left loudspeaker.

While the individual channel on screen is blinking, press the enter key (84), then use the direction keys to adjust each loudspeaker's setting until the SPL meter reads 75 dB.

Press enter to set each selection, then use the direction keys to move to the next loudspeaker.

Repeat this process for all loudspeakers. Press the previous key once to return to the calibration room setup screen.

---

**Note** *Any speaker not configured in the SPEAKER SETUP menu displays N/A (not available) for the dB specification.*

**Program Material Option** Press the enter key to choose PROGRAM MATERIAL. The program material screen appears.

The program material option requires external program material such as a test disc. The source plays, simultaneously, from all configured loudspeakers. Use the enter and direction keys to individually adjust loudspeaker balances based on your listening preferences rather than SPL readings. If all channels are not present in the source material, they will not be heard during this process.

**Please read  
before continuing  
on to Step 4**

To help you understand the numerous configuration options available through the Home Theater Standard 7.1, Step 4 illustrates configuring a specific source device: a DVD player.

To configure other source devices, Krell recommends that you configure one device at a time, using the menu's step-by-step format.

---

**IMPORTANT**

***Some Home Theater Standard 7.1 configurations are designed for digital only, and some are designed for analog only. If you try to format an analog source device using a digital configuration, the menu will not let you proceed.***

**STEP 4  
CONFIGURE DEVICES**

The fourth option on the main menu screen, CONFIGURE DEVICES, allows you to assign video and audio inputs to source devices and configure triggers for devices in the system.

Select CONFIGURE DEVICES on the MAIN MENU. The CONFIGURE DEVICES screen appears, with the cursor blinking at CONFIGURE VIDEO.

**Configure Devices Screen**

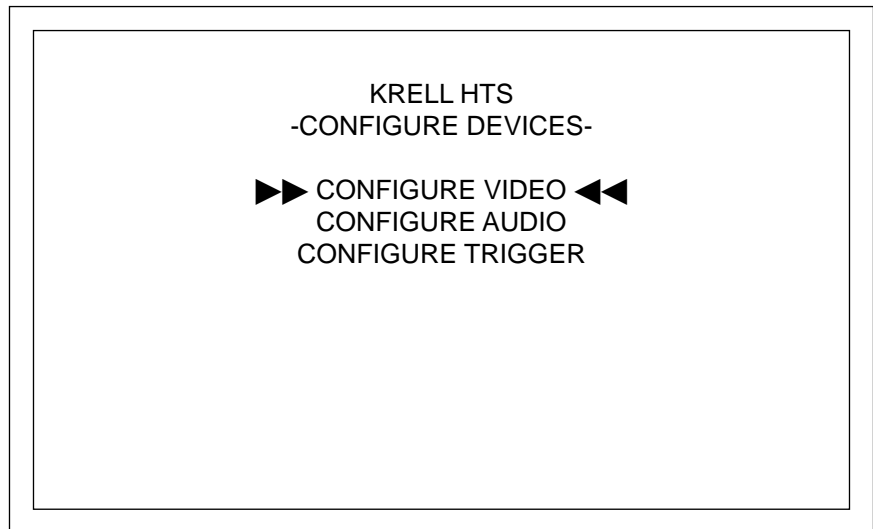

**How To Navigate the Menu  
and Make a Selection**

1. Use the direction keys to scroll from line to line.
2. Press enter to select a line.
3. Use the direction keys to scroll through options within a line.
4. Press enter to select and set an option.
5. Use the direction keys to scroll to the next line.

**Please read  
before assigning  
video inputs**

The Home Theater Standard 7.1 is shipped with separate factory default video inputs and standards for North American and international operation. See **Table 1** and **Table 2** below.

---

**Table 1 Factory Default Video Inputs and Standards for the Home Theater Standard 7.1, North American Operation**

<b>Device</b>	<b>Assigned Input</b>	<b>Video Standard</b>
DVD	Component 1	NTSC Interlaced
LD	Composite 1	NTSC Interlaced
SAT	S-Video 1	NTSC Interlaced
VCR	S-Video 2	NTSC Interlaced
TV	Composite 2	NTSC Interlaced
CD	Disabled	N/A
Tuner	Disabled	N/A
Aux 1	Disabled	N/A
Aux 2	Disabled	N/A
Tape	Composite 3	NTSC Interlaced

---

**Table 2 Factory Default Video Inputs and Standards for the Home Theater Standard 7.1, International Operation**

<b>Device</b>	<b>Assigned Input</b>	<b>Video Standard</b>
DVD	Component 1	NTSC Interlaced
LD	Composite 1	NTSC Interlaced
SAT	S-Video 1	NTSC Interlaced
VCR	S-Video 2	PAL Interlaced
TV	Component 2	PAL Interlaced
CD	Composite 2	PAL Interlaced
Tuner	Disabled	N/A
Aux 1	Disabled	N/A
Aux 2	Disabled	N/A
Tape	Composite 3	NTSC Interlaced

---

**Note**

*Video factory defaults for the Home Theater Standard 7.1 do not need to be configured if your system matches the factory defaults.*

## Assign Video Input

Select CONFIGURE VIDEO from the CONFIGURE DEVICES menu. The ASSIGN VIDEO INPUT screen appears, with the cursor blinking at DVD.

### Assign Video Input Screen

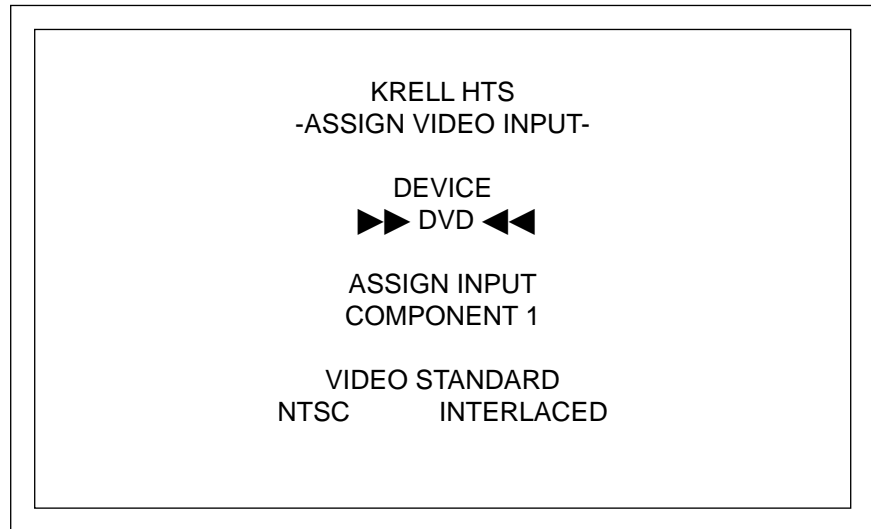

The ASSIGN VIDEO INPUT screen lets you select the device to configure and assign an input to the device. Assigned inputs correspond to the inputs on the back panel. For devices that do not use a video input, for example, a CD player, there are two options: PREVIOUS or DISABLED.

#### PREVIOUS

This selection allows the last active video input to continue to be displayed, as long as a previous selection has been made.

#### DISABLED

This selection turns off the video outputs.

You may also choose a standard video format, either NTSC or PAL, and select whether the component signals are INTERLACED or PROGRESSIVE/HD, depending upon your video monitor capabilities.

#### INTERLACED

These signals build screen content in two passes.

#### PROGRESSIVE/HD

These signals build screen content in one pass, eliminating motion artifacts and produces film-quality pictures. Both your source and video monitor must be equipped with progressive video technology to realize this advantage.

Use the direction and enter keys to navigate through the menu and set selections. When all selections are entered, press the previous key once to return to the CONFIGURE DEVICES menu.

### How To Navigate the Menu and Make a Selection

1. Use the direction keys to scroll from line to line.
2. Press enter to select a line.
3. Use the direction keys to scroll through options within a line.
4. Press enter to select and set an option.
5. Use the direction keys to scroll to the next line.

**System Configuration, continued**

**Please read before configuring audio and digital inputs**

The Home Theater Standard 7.1 is shipped with factory defaults for analog and digital inputs. These defaults are the same for domestic and international operation, and are listed in **Table 4** below:

**Table 3 Factory Default Digital and Analog Audio Inputs for the Home Theater Standard 7.1, North American and International Operation**

	Digital	Analog	Digital				Analog
			Dolby Digital 2.0	Dolby Digital 5.1	DTS 5.1	PCM	
DVD	Coax 1	S1	Dolby D + Dolby PLII Movie	Dolby D 5.1	DTS 5.1 Movie	Dolby PLII Movie	Dolby PLII Movie
LD	Coax 2	S2	Dolby D + Dolby PLII Movie	Dolby D 5.1	DTS 5.1 Movie	Dolby PLII Movie	Dolby PLII Movie
SAT	Opt 1	S3	Dolby D + Dolby PLII Movie	Dolby D 5.1	DTS 5.1 Movie	Dolby PLII Movie	Dolby PLII Movie
VCR	Disabled	VCR	N/A	N/A	N/A	N/A	Dolby PLII Movie
TV	Disabled	S4	N/A	N/A	N/A	N/A	Dolby PLII Movie
CD	Disabled	B1	N/A	N/A	N/A	N/A	Preamp
Tuner	Disabled	S5	N/A	N/A	N/A	N/A	Preamp
Aux 1	Disabled	7.1 Input	N/A	N/A	N/A	N/A	N/A
Aux 2 (Game)	Opt 2	S6	N/A	Dolby D 5.1	DTS 5.1	Dolby PLII Movie	Preamp
Tape	Disabled	Tape	N/A	N/A	N/A	N/A	Preamp

**Note**

*Audio factory defaults for the Home Theater Standard 7.1 do not need to be configured if your system matches the factory defaults.*

**Table 4**, on the next page, shows the audio operating modes available with the Home Theater Standard 7.1. See also **Appendix: Operating Modes for the Home Theater Standard 7.1**, on page 75, for descriptions of operating modes listed in Table 4.

**Table 4 Home Theater Standard 7.1 Factory Default Audio Operating Modes**

Possible Default Operating Modes	Digital Signals (4 formats)				Analog Signal	
	Dolby Digital 2.0	Dolby Digital 5.1	DTS 5.1	PCM		
Dolby D + PLII Movie	YES	—	—	—	—	—
Dolby D + PLII Movie + THX	YES	—	—	—	—	—
Dolby D + PLII Music	YES	—	—	—	—	—
Dolby D + PLII Matrix	YES	—	—	—	—	—
Dolby D + Dolby Pro Logic	YES	—	—	—	—	—
Dolby D + Pro Logic + THX	YES	—	—	—	—	—
Dolby D 2.0	YES	—	—	—	—	—
Dolby D 5.1	—	YES	—	—	—	—
Dolby Digital EX <sup>1</sup>	—	YES	—	—	—	—
Dolby D 5.1 + THX	—	YES	—	—	—	—
Dolby D 5.1 + THX Surr EX <sup>1</sup>	—	YES	—	—	—	—
Dolby PLII Movie	—	—	—	YES	YES	YES
Dolby PLII Movie + THX	—	—	—	YES	YES	YES
Dolby PLII Music	—	—	—	YES	YES	YES
Dolby PLII Matrix	—	—	—	YES	YES	YES
Dolby Pro Logic	—	—	—	YES	YES	YES
Dolby Pro Logic + THX	—	—	—	YES	YES	YES
DTS 5.1 Movie <sup>3</sup>	—	—	YES	—	—	—
DTS 5.1 Movie + THX <sup>3</sup>	—	—	YES	—	—	—
DTS 5.1 Music <sup>3</sup>	—	—	YES	—	—	—
DTS 5.1 Only <sup>2,3</sup>	—	—	YES	—	—	—
DTS Neo:6 Cinema	—	—	—	YES	YES	YES
DTS Neo:6 Cinema + THX	—	—	—	YES	YES	YES
DTS Neo:6 Music	—	—	—	YES	YES	YES
Krell Music Surround	—	—	—	YES	YES	YES
Preamp	—	—	—	—	YES	YES
Stereo	—	—	—	YES	YES	YES

<sup>1</sup> The DOLBY DIGITAL EX and DOLBY D 5.1 + THX SURR EX operating modes are available only when your system has 6 or 7 channels.

<sup>2</sup> DTS 5.1 ONLY sets an input to receive only DTS 5.1 information. When this mode is selected, you are unable to select a default mode for PCM, Dolby Digital 2.0, and Dolby Digital 5.1 signals; the input will playback only DTS 5.1 material.

<sup>3</sup> When the Home Theater Standard 7.1 detects a DTS 5.1 signal and engages the default mode selected for a DTS 5.1 signal, DTS-ES MATRIX 6.1 and DTS-ES MATRIX 6.1 + THX are accessible by pressing the M2 button or key. The DTS-ES MATRIX 6.1 operating mode is available only when your system has 6 or 7 channels.

**Note**

The DOLBY DIGITAL EX, DOLBY D 5.1 + THX SURR EX, DTS-ES DISCRETE 6.1, and DTS-ES MATRIX 6.1 operating modes are available only when your system has 6 or 7 channels.



## Assign Analog Audio Inputs

Select CONFIGURE AUDIO from the CONFIGURE DEVICES menu. The ASSIGN AUDIO INPUTS screen appears, with the cursor blinking at ANALOG.

### Assign Audio Inputs Screen

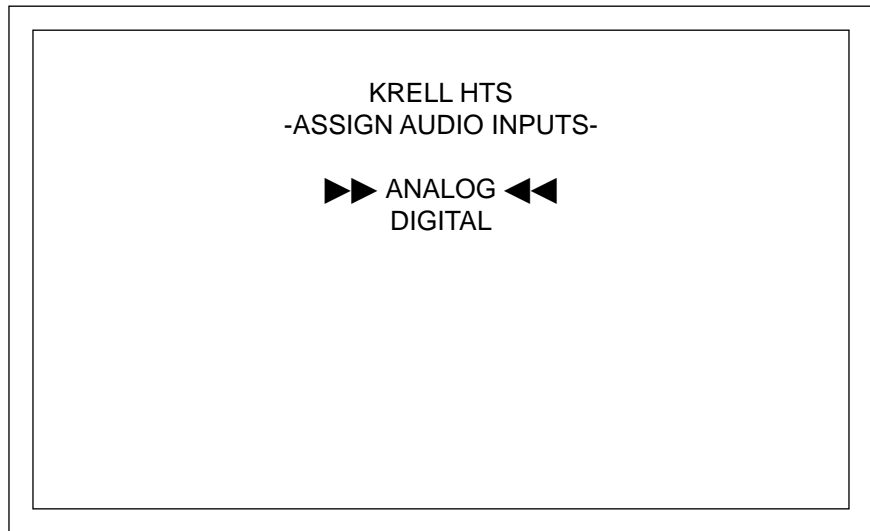

Select ANALOG. The ASSIGN ANALOG AUDIO INPUT screen appears, with the cursor blinking at DVD.

### Assign Analog Audio Input Screen

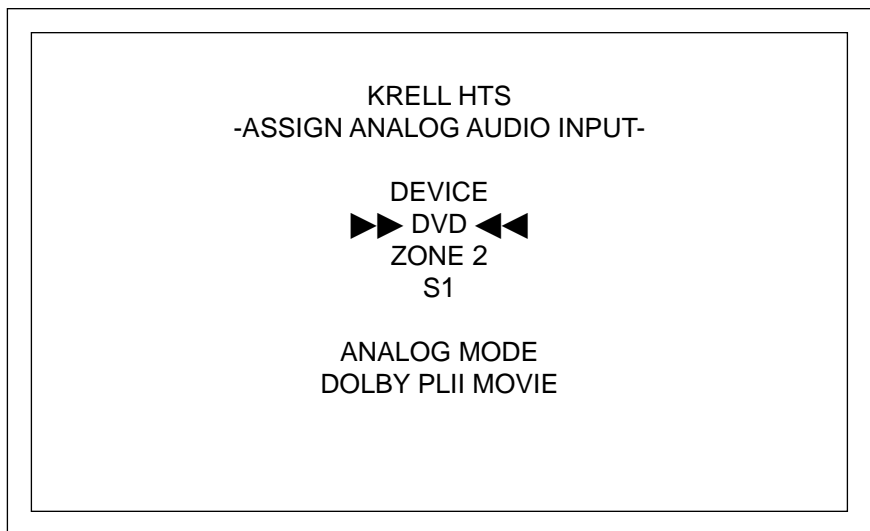

Use the direction and enter keys to scroll through and select the device you want to configure, select the analog input, and choose the analog mode.

After the selections for analog audio inputs are entered, press the previous key to return to the ASSIGN AUDIO INPUTS screen.

## Assign Digital Audio Inputs

### Assign Digital Audio Input Screen

Select **DIGITAL** from the **ASSIGN AUDIO INPUTS** screen. The **ASSIGN DIGITAL AUDIO INPUTS** screen appears, with the cursor blinking at **DVD**.

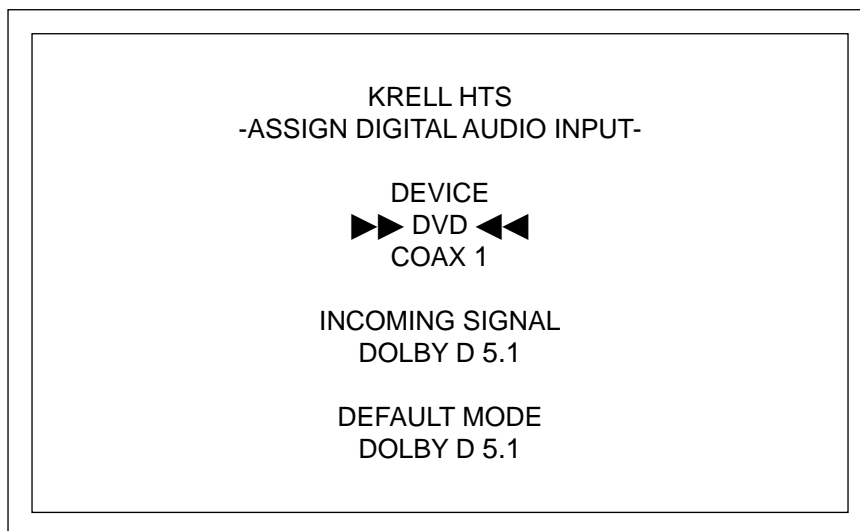

Use the direction and enter keys to scroll through and select the digital device you want to configure, select the analog input, and choose the default mode for the four digital signal sound formats: **DOLBY DIGITAL 2.0**, **DOLBY DIGITAL 5.1**, **DTS 5.1**, and **PCM**. Each of these signals has options under **DEFAULT MODE**. If a **THX Surround EX** or **DTS ES** encoded disc is played, the Home Theater Standard 7.1 will automatically select one of these modes.

### Notes

*The digital input must be set to **DISABLED** to use the analog input for the main zone.*

*The digital input must be **DISABLED** to use preamp mode.*

***PREVIOUS** holds the last selected digital input.*

When the device is configured, press the previous key twice to return to the **CONFIGURE DEVICES** menu.

### How To Navigate the Menu and Make a Selection

1. Use the direction keys to scroll from line to line.
2. Press enter to select a line.
3. Use the direction keys to scroll through options within a line.
4. Press enter to select and set an option.
5. Use the direction keys to scroll to the next line.

## Configure Trigger

The final option on the CONFIGURE DEVICES menu is CONFIGURE TRIGGER. This option allows you to customize the operation of the four remote output 12 VDC (12 Volt trigger) connectors (54) on the back panel.

Select CONFIGURE TRIGGER from the CONFIGURE DEVICES menu. The CONFIGURE TRIGGER screen appears, with the cursor blinking at DVD.

## Configure Trigger Screen

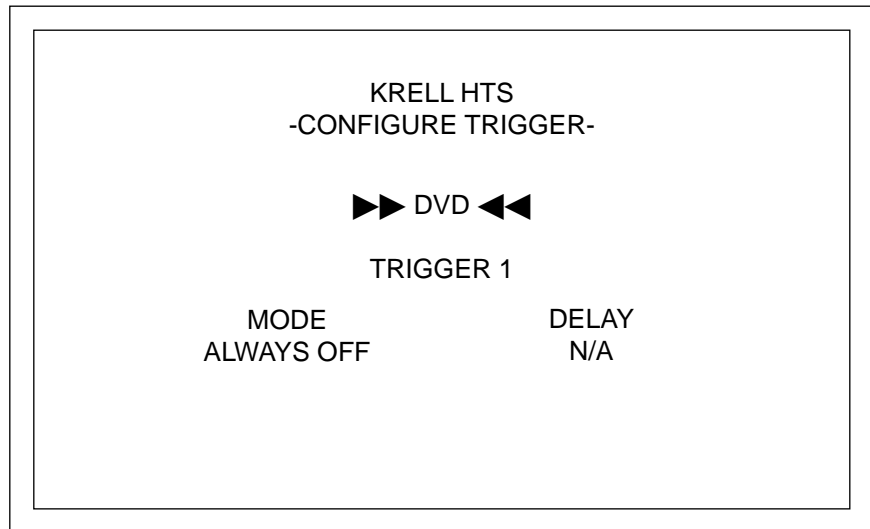

Use the direction (81) and enter (84) keys to select the source device, the trigger(s) you want to configure, and the mode and delay for each trigger you select. The delay is only available when a trigger is set to activate.

## Trigger Modes

### ALWAYS OFF

This trigger is not activated when the configured device is selected.

### MAIN AND ZONE 2

The trigger activates when the configured device is selected for main zone or zone 2 listening.

### MAIN ONLY

The trigger activates only when the configured device is selected for main zone listening.

### ZONE 2 ONLY

The trigger activates only when the device is selected for zone 2 listening.

### **Configuring Additional Inputs**

For any of the other devices available (LD, SAT, VCR1, TV, CD, TUNER, AUX1, AUX2, TAPE), use the same process outlined above. Krell recommends that you use the step-by-step menu to configure each device completely, then configure the next device.

When you have configured all the devices you want, press the previous button twice to return to the main menu.

### **How To Navigate the Menu and Make a Selection**

1. Use the direction keys to scroll from line to line.
2. Press enter to select a line.
3. Use the direction keys to scroll through options within a line.
4. Press enter to select and set an option.
5. Use the direction keys to scroll to the next line.

**STEP 5**  
**CONFIGURE LEVEL**  
**ADJUSTMENT**

Use the fifth option on the main menu, CONFIGURE LEVEL ADJUSTMENT to set trims, adjust modes, set the main volume limit, and set up zone 2 volume control.

Trims add a fixed positive or negative volume offset for devices with different volume levels. After adjusting the volume trim, you can easily switch between these inputs without changes in volume levels. The Home Theater Standard 7.1 uses two types of trims: master volume trims and taste trims.

Master volume trims (device, analog, and music mode sub trim) change the volume of all speakers at once. These master volume trims are programmed, and do not change unless reprogrammed through the menu.

Taste trims adjust individual speakers during playback. Use the level buttons or keys to make adjustments. Taste trims are not programmed and are temporary.

**Note**

*The master volume control has a numerical range from 0 to 152, with 31 as the Dolby reference level. The center loudspeaker, surround loudspeakers, and subwoofer volume trims have a range of +/- 15 dB.*

Select CONFIGURE LEVEL ADJUSTMENT from the main menu. The CONFIGURE LEVELS screen appears, with the cursor blinking at DEVICE TRIM.

**Configure Levels Screen**

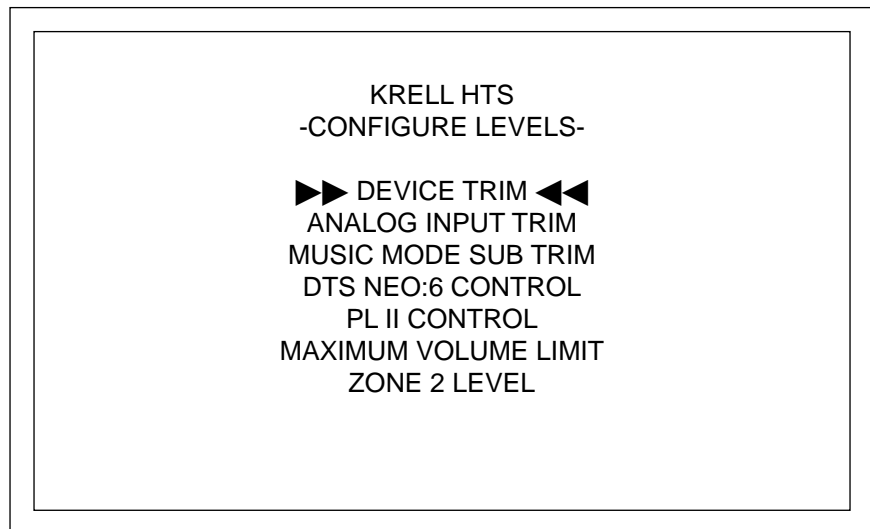

### **Device Trim**

The `DEVICE TRIM` is a master volume trim that is activated when an input device is selected; it has a range of + 15 dB to - 15 dB.

Select `DEVICE TRIM` from the `CONFIGURE LEVELS` menu. The `DEVICE TRIM` screen appears, with the cursor blinking at `DVD`.

### **Device Trim Screen**

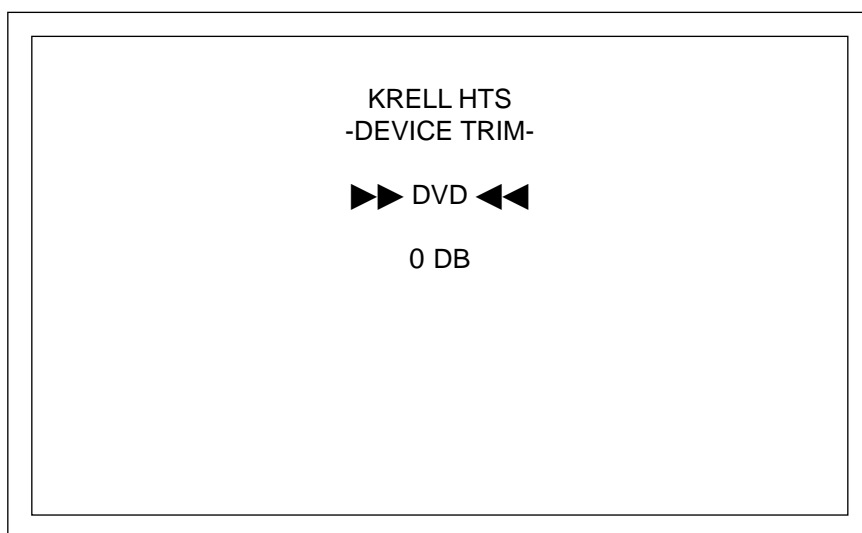

Use the direction and enter keys to select the devices for which you want to set trims, and the trim level for each. When you have made your selections, press the previous key once to return to the `CONFIGURE LEVELS` screen.

### **How To Navigate the Menu and Make a Selection**

1. Use the direction keys to scroll from line to line.
2. Press enter to select a line.
3. Use the direction keys to scroll through options within a line.
4. Press enter to select and set an option.
5. Use the direction keys to scroll to the next line.

**Please read before  
configuring  
analog input trim**

An analog device must be selected before the analog input trim option functions. The following screen appears if an analog device is not selected:

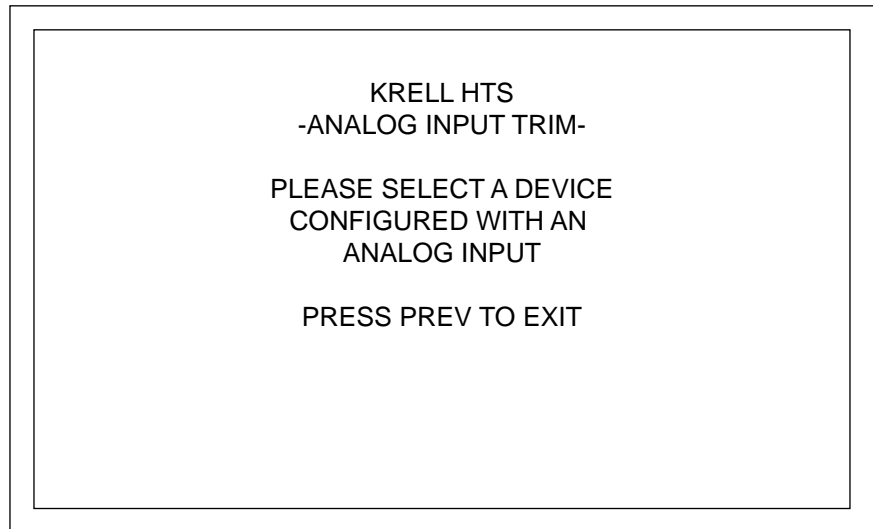

## Analog Input Trim

Use the ANALOG INPUT TRIM menu to measure the level of an analog input source to the Home Theater Standard 7.1.

Select ANALOG INPUT TRIM from the CONFIGURE LEVELS menu. The ANALOG INPUT TRIM screen appears:

### Analog Input Trim Screen

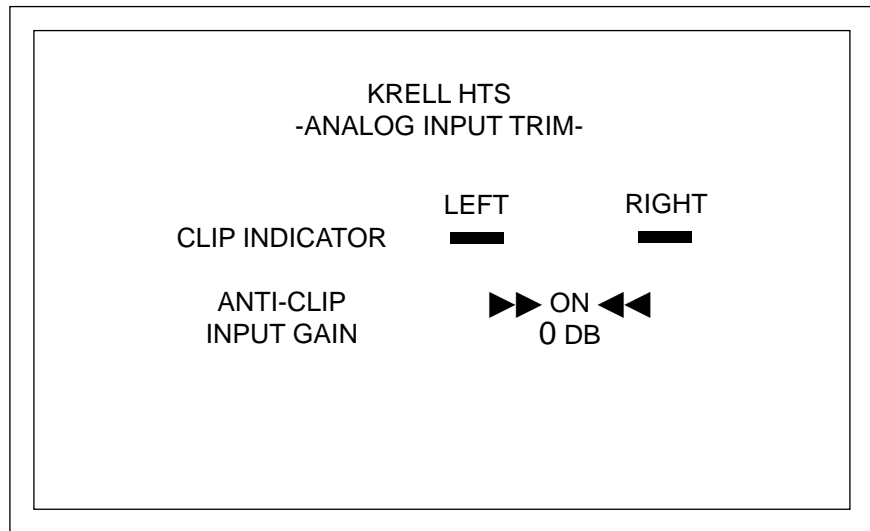

Use the direction keys (81) to select the anti-clip option you want (ON or OFF) and the input gain decibel level.

### ANTI-CLIP

ON

The anti-clip function measures the signal level and prevents the input signal from overloading (clipping) the analog-to-digital converters.

OFF

Disengages the anti-clip function.

### INPUT GAIN

Boost weaker signals by increasing the input gain value. Use the direction and enter keys to select the number of dB.

To maximize your system's signal-to-noise ratio without clipping, increase the input gain value applied to the signal until you see the clip indicator illuminate on the screen; then back the input gain value off 1 dB. The optimal signal gain value will vary from source to source.

### How To Navigate the Menu and Make a Selection

1. Use the direction keys to scroll from line to line.
2. Press enter to select a line.
3. Use the direction keys to scroll through options within a line.
4. Press enter to select and set an option.
5. Use the direction keys to scroll to the next line.

After selecting the anti-clip and input gain options for your analog devices, press the previous key (80) once to return to the CONFIGURE LEVELS menu.



**Music Mode Sub Trim**

Use the MUSIC MODE SUB TRIM menu to adjust the trim for the subwoofer, during music mode playback. The adjustment range is -10 to +10 dB. Music mode sub trim is active when using the PARTY, GENERAL ADMISSION, FRONT ROW, ON STAGE, ENHANCED STEREO, ORCHESTRA, MEZZANINE, FULL RANGE + SUB, and DTS NEO:6 modes.

Select MUSIC MODE SUB TRIM from the CONFIGURE LEVELS menu. The MUSIC MODE SUB TRIM screen appears:

**Music Mode Sub Trim Screen**

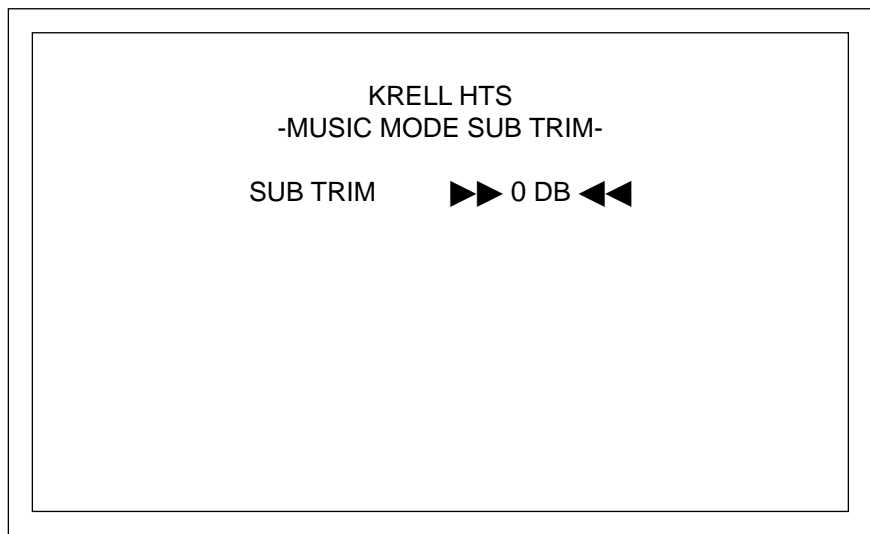

After setting the selection, press the previous key once to return to the CONFIGURE LEVELS menu screen.

### **DTS Neo:6 Control**

Use the DTS NEO:6 CONTROL menu to adjust the signal for the DTS Neo:6 music mode, which derives a 6.0 signal from two-channel material. The center gain adjusts the amount of center channel information present in the left and right loudspeakers. The adjustment range is 0 (no center channel information; wide sound field) to 5 (maximum level of center channel information subtracted from the left and right channels; narrow sound field).

Select DTS NEO:6 CONTROL from the CONFIGURE LEVELS menu. The DTS CONTROL screen appears, with the cursor blinking at 2:

### **DTS Control Screen**

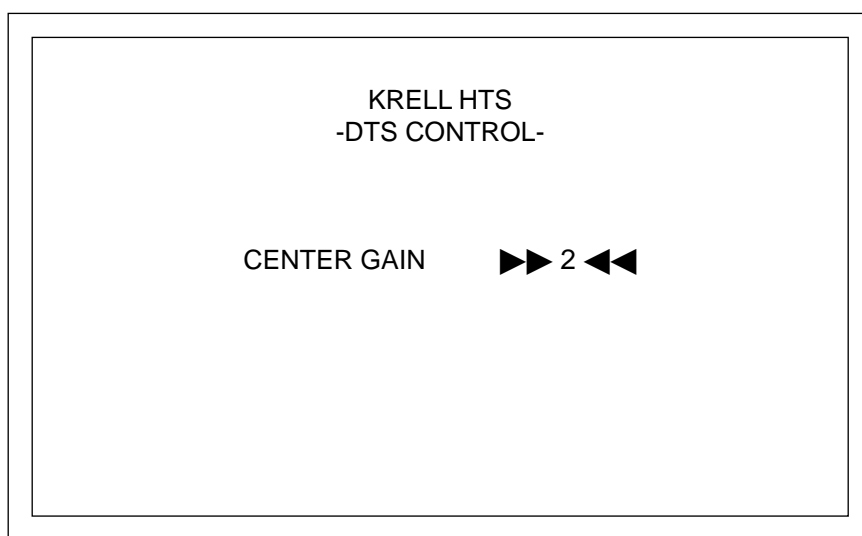

After setting the selection, press the previous key once to return to the CONFIGURE LEVELS screen.

### **How To Navigate the Menu and Make a Selection**

1. Use the direction keys to scroll from line to line.
2. Press enter to select a line.
3. Use the direction keys to scroll through options within a line.
4. Press enter to select and set an option.
5. Use the direction keys to scroll to the next line.

## **PLII Control**

Use the PLII CONTROL menu to adjust the signal for Dolby Prologic II music mode, which derives a 6.0 signal from two-channel material.

Select PLII CONTROL from the CONFIGURE LEVELS menu. The PLII CONTROL screen appears, with the cursor blinking at the center width value.

## **PLII Control Screen**

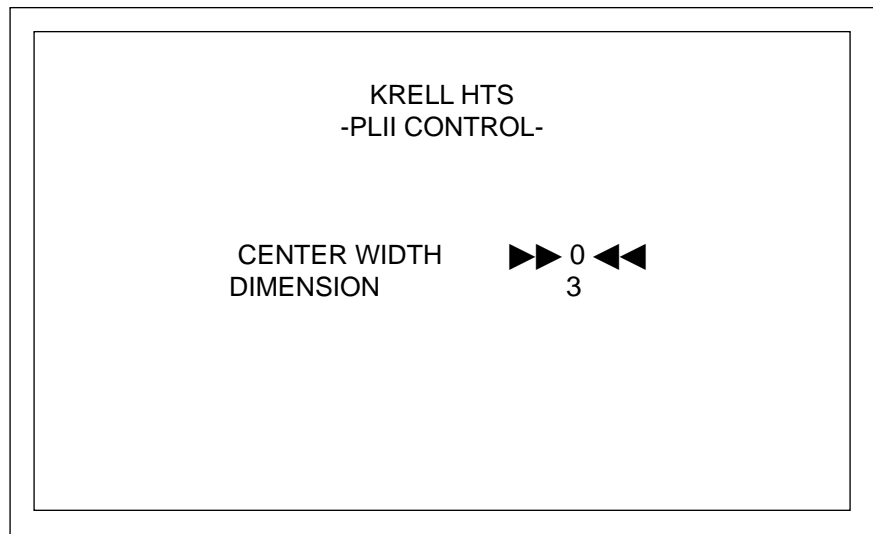

### **DIMENSION**

You can adjust the sound field toward the front or rear loudspeakers, to achieve a more suitable balance from all loudspeakers with certain recordings. The adjustment range is 0 (maximum surround) to 6 (maximum center). The default setting is 3 (neutral).

### **CENTER WIDTH**

You can adjust how much of the center output signal is spread to the left and right channel outputs. The adjustment range is from 0 (lowest) to 7 (highest, effectively mutes the center channel).

After setting your selections, press the previous key once to return to the CONFIGURE LEVELS screen.

---

**System Configuration, continued**

**Maximum Volume Limit**

Use the `MAXIMUM VOLUME LIMIT` menu to adjust the maximum volume for your system, from 0-152.

**Note**

*Maximum volume affects the main zone and zone 2.*

Select `MAXIMUM VOLUME LIMIT` from the `CONFIGURE LEVELS` menu. The `MAXIMUM VOLUME LIMIT` screen appears:

**Maximum Volume Limit Screen**

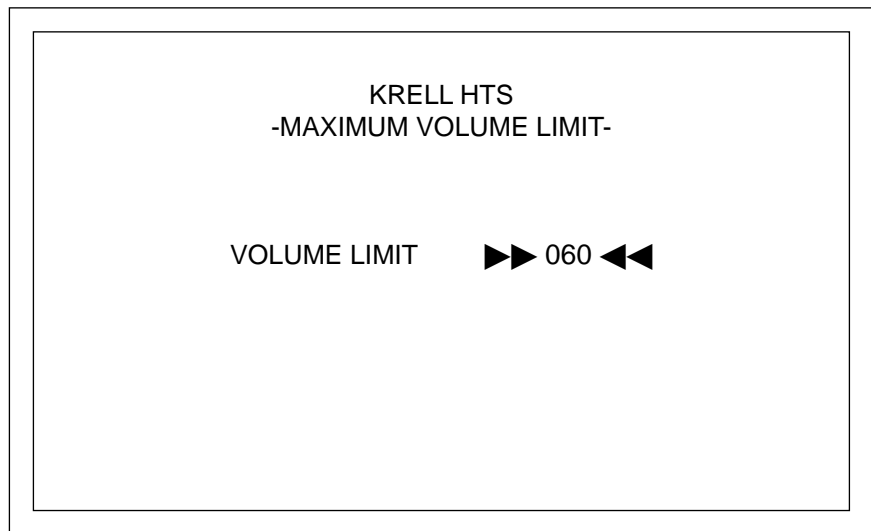

After setting your selection, press the previous key (80) once to return to the `CONFIGURE LEVELS` screen.

**How To Navigate the Menu and Make a Selection**

1. Use the direction keys to scroll from line to line.
2. Press enter to select a line.
3. Use the direction keys to scroll through options within a line.
4. Press enter to select and set an option.
5. Use the direction keys to scroll to the next line.

**Zone 2 Level**

Use the ZONE 2 LEVEL menu to select a FIXED or VARIABLE output from zone 2.

Select ZONE 2 LEVEL from the CONFIGURE LEVELS menu. The ZONE 2 LEVEL screen appears, with the cursor blinking at VARIABLE.

**Zone 2 Level Screen**

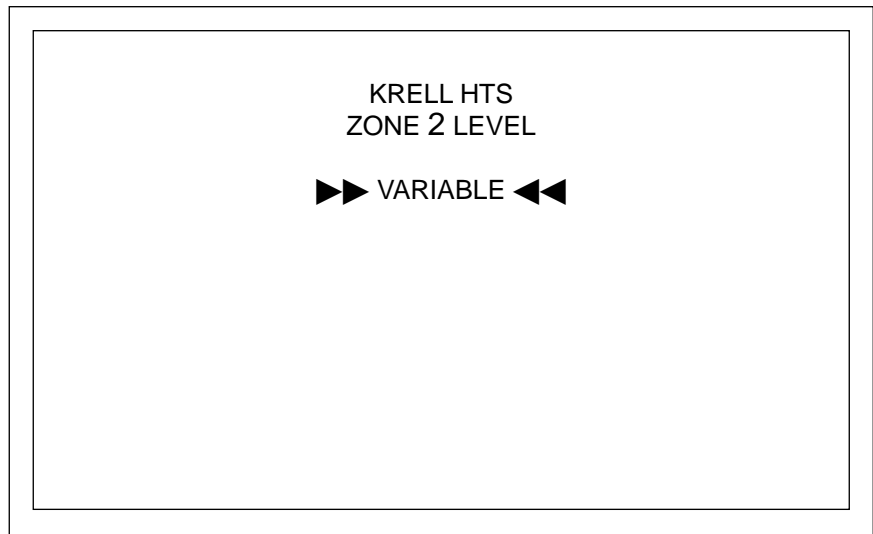

After setting your selections, press the previous key (80) once to return to the CONFIGURE LEVELS screen. Press the previous key again to return to the main menu screen to configure other source devices.

**STEP 6  
OPERATION**

The final option on the main menu screen, OPERATION, lets you select screen background color, position and display time for on-screen display (OSD), set audio operation, program a learning remote control, and adjust frequency response using the Krell Digital Room Equalizer.

Select OPERATION menu from the MAIN MENU. The OPERATION MENU screen appears, with the cursor blinking at OSD OPERATION.

**Operation Screen**

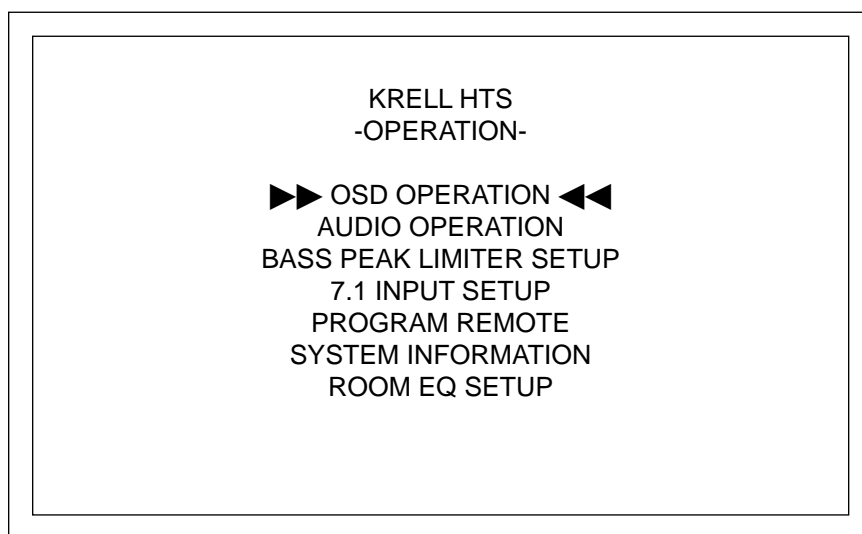

**OSD Operation**

Press enter to access the OSD OPERATION screen. The cursor is blinking at the currently selected background color.

**OSD Operation Screen**

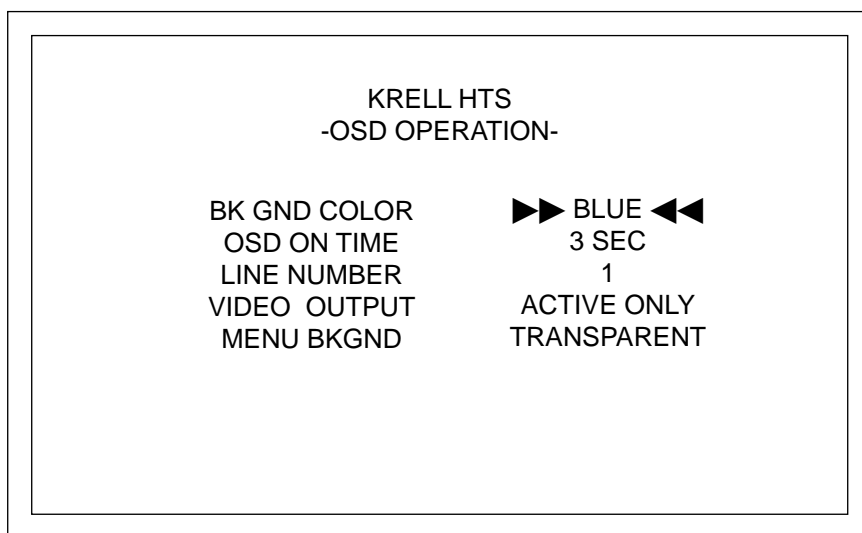

**How To Navigate the Menu  
and Make a Selection**

1. Use the direction keys to scroll from line to line.
2. Press enter to select a line.
3. Use the direction keys to scroll through options within a line.
4. Press enter to select and set an option.
5. Use the direction keys to scroll to the next line.

---

## **System Configuration, continued**

### **OSD Operation, continued**

The on-screen display feature allows you to customize on-screen display options.

#### BACKGROUND COLOR

Choose the background color of the video display screen. This color choice is only applicable to composite and S-video inputs. The background color is always black for component signals.

#### OSD ON TIME

Choose the number of seconds (0-10) that the on-screen display information remains on the screen.

#### LINE NUMBER

Choose the location (from 1, top line, to 10, bottom line) at which the on-screen display appears.

#### VIDEO OUTPUT

Choose **ACTIVE ONLY**, to deactivate remaining video outputs when one is selected (for example, to turn off all component or s-video outputs when the composite output is selected), or **ALL**, to keep all video outputs active when one is selected.

#### MENU BKGND

Choose the menu background, either **SOLID** or **TRANSPARENT**. The **SOLID** setting blanks out an active video signal and only displays menu information. The **TRANSPARENT** setting overlays the menu screens on top of an active video signal, allowing configuration changes while continuing to watch a video signal.

After setting your selections, press the previous key (80) once to return to the **OPERATION** menu.

## Audio Operation

The next item in the OPERATION menu, AUDIO OPERATION, allows you to customize audio operation such as mute, mode holds, auto-switching, and dynamic range.

Select AUDIO OPERATION from the OPERATION menu. The AUDIO OPERATION screen appears:

### Audio Operation Screen

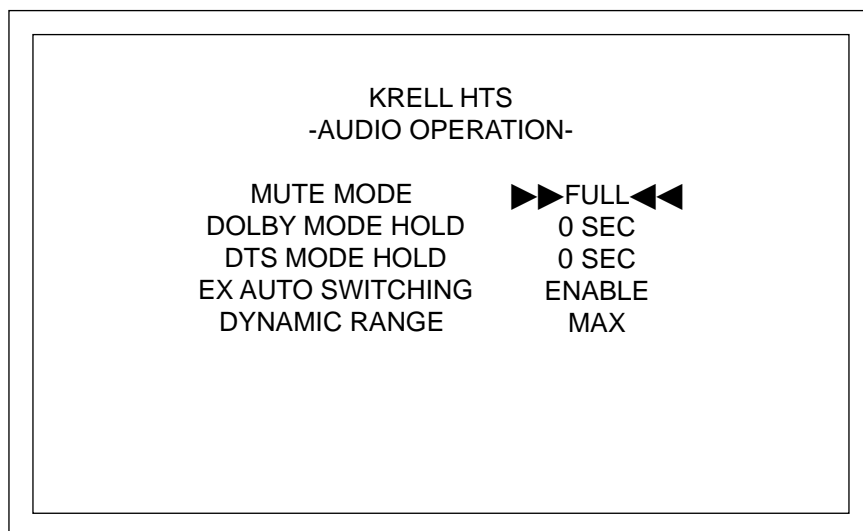

Use the direction and enter keys to scroll through and select options for audio operation:

#### MUTE MODE

The mute mode lets you select FULL mode in which the output is completely silenced or you may select -20 dB in which the output is reduced by 20 dB and may still be audible.

#### DOLBY MODE HOLD

Dolby mode hold sets the time your Home Theater Standard 7.1 remains in Dolby Digital mode when the incoming bitstream is interrupted. Bitstreams are interrupted in some devices when you press and release fast forward, track back/forward, or change channels for a compact disc, video disc, or satellite receiver. The adjustment range is 0 (no hold) to 30 seconds.

#### DTS MODE HOLD

DTS mode hold sets the time your Home Theater Standard 7.1 remains in DTS mode when the incoming bitstream is interrupted. Bitstreams are interrupted in some devices when you press and release fast forward, track back/forward, or change channels for a compact disc, video disc, or satellite receiver. The adjustment range is 0 (no hold) to 30 seconds.

#### How To Navigate the Menu and Make a Selection

1. Use the direction keys to scroll from line to line.
2. Press enter to select a line.
3. Use the direction keys to scroll through options within a line.
4. Press enter to select and set an option.
5. Use the direction keys to scroll to the next line.



---

**System Configuration, continued**

**Audio Operation, continued**

EX AUTO SWITCHING

When **ENABLED**, the Home Theater Standard 7.1 will automatically engage THX Surround EX decoding if it receives a bitstream that is encoded in this format. When this feature is **DISABLED**, you must manually select THX Surround EX decoding.

DYNAMIC RANGE

Use the dynamic range screen to adjust the dynamic range of the Home Theater Standard 7.1. Options are:

NORMAL

11 dB of compression

MAX

no compression

NIGHT

22 dB of compression

After setting your selections, press the previous key (80) once to return to the **OPERATION** menu.

## **Bass Peak Limiter Setup**

The **BASS PEAK LIMITER SETUP** menu lets you turn the bass peak limiter option **ON** or **OFF**. When this option is **ON**, you can then set the maximum amount of .1 (or LFE) and redirected bass that is sent to your subwoofer. If you do not have a subwoofer, this option limits the maximum amount of 1 (or LFE) and redirected bass that is sent to your full range front and/or surround loudspeakers.

Select **BASS PEAK LIMITER SETUP** from the **OPERATION** menu. The **BASS PEAK LIMITER SETUP** screen appears, with the cursor blinking at **OFF**.

### **Bass Peak Limiter Setup Screen**

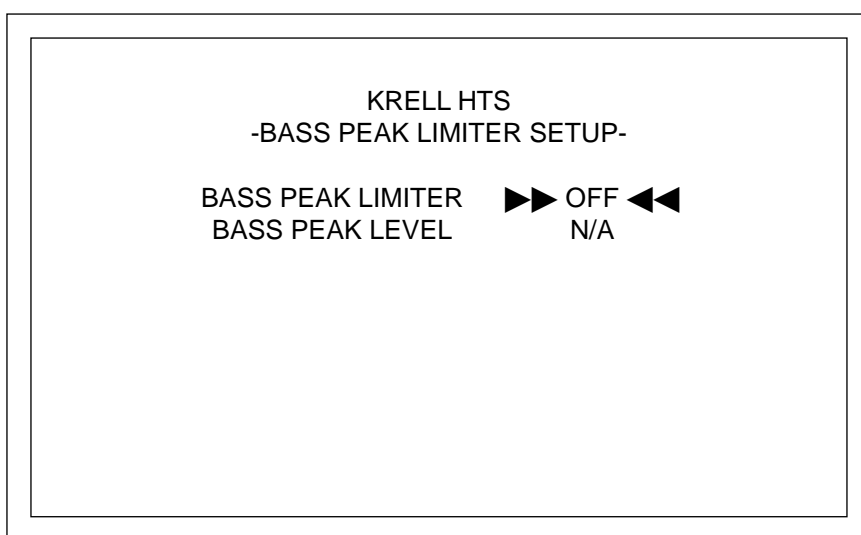

When you select **ON**, the **BASS PEAK LEVEL** reverts to 0. Use the up direction key to increase the output of the noise generator. Select the volume level limit (0-90) by increasing the noise generator until the bass sounds distorted. Then select that level, or slightly below.

After setting your selections, press the previous key once to return to the **OPERATION** screen.

### **How To Navigate the Menu and Make a Selection**

1. Use the direction keys to scroll from line to line.
2. Press enter to select a line.
3. Use the direction keys to scroll through options within a line.
4. Press enter to select and set an option.
5. Use the direction keys to scroll to the next line.

## 7.1 Input Setup

The 7.1 INPUT SETUP menu allows you to select the 7.1 inputs that are connected.

Select 7.1 INPUT SETUP from the OPERATION menu. The 7.1 INPUT SETUP screen appears, with the cursor blinking on an active 7.1 input selection.

### 7.1 Input Setup Screen

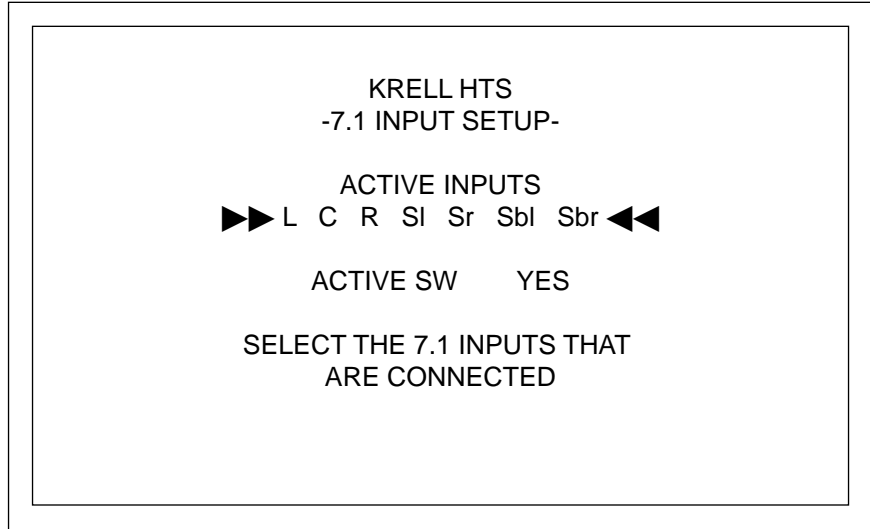

#### ACTIVE INPUTS

Use the direction keys to find the input combination that matches your connections. Press enter to set the selection.

#### ACTIVE SW

Select YES if subwoofer is present and NO if it is not.

After setting your selections, press the previous key (80) once to return to the OPERATION menu.

#### How To Navigate the Menu and Make a Selection

1. Use the direction keys to scroll from line to line.
2. Press enter to select a line.
3. Use the direction keys to scroll through options within a line.
4. Press enter to select and set an option.
5. Use the direction keys to scroll to the next line.

**Program Remote**

The final item on the OPERATION menu, PROGRAM REMOTE, allows you to program a learning remote control to operate the Home Theater Standard 7.1.

---

**Note**

*The infrared sensor on the front panel is inactive until programming is complete.*

Select PROGRAM REMOTE from the OPERATION menu. The PROGRAM REMOTE screens appears with the cursor blinking at START.

**Program Remote Screen A**

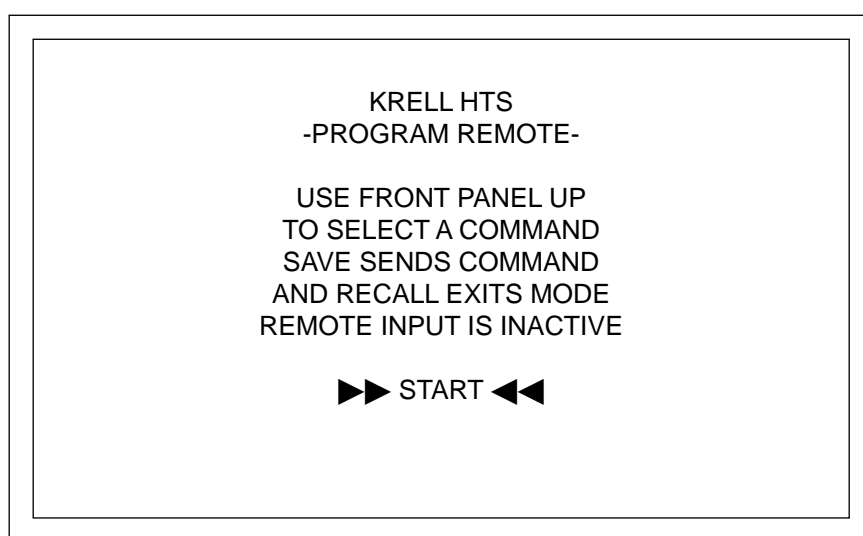

After you press START, the following screen appears:

**Program Remote Screen B**



---

**Note**

*Press the recall button (31) on the front panel to return to Program Remote Screen A. Then press the previous key on the Home Theater Standard 7.1 remote control to return to the operation screen.*

---

## System Configuration, continued

### Program Remote, continued

Follow these steps to program your learning remote:

1. Press the front panel level buttons (30) to select a command. The command appears on the front panel display window (24).
2. Place the programmable remote in program mode (see the learning remote user manual).
3. Place the infrared sensor of the programmable remote so that it faces the infrared emitter (17) on the Home Theater Standard 7.1 front panel.
4. Press and hold the save button (29) on the Home Theater Standard 7.1 front panel until the programmable remote has learned the code (see the learning remote user manual for information on the time needed to learn the code).
5. Select and save as many commands as desired.
6. Press the recall button (31) on the front panel to return to Program Remote Screen A. Then press the previous key on the Home Theater Standard 7.1 remote control to return to the operation screen.

## System Information

The SYSTEM INFORMATION menu displays AC line frequency, the version of software that your component is currently using, and information about the EEPROM.

Select SYSTEM INFORMATION from the OPERATION menu. The SYSTEM INFORMATION screen appears.

### System Information Screen

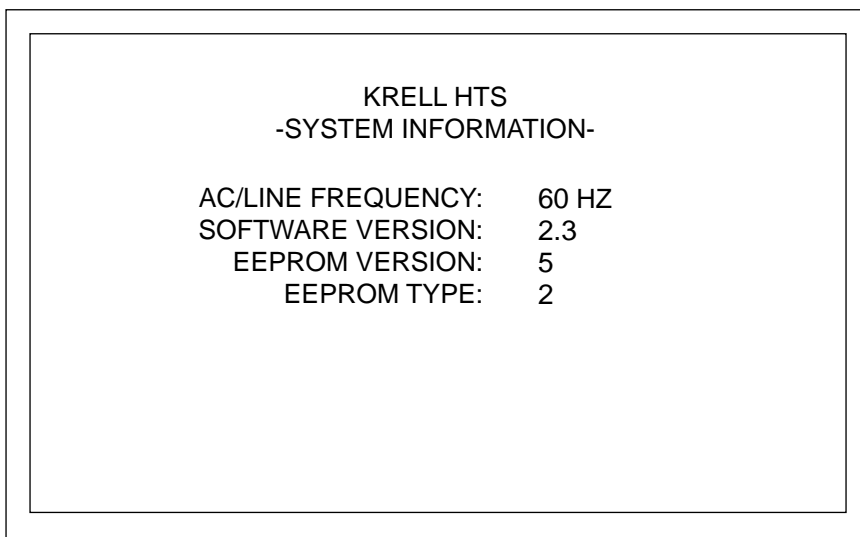

#### How To Navigate the Menu and Make a Selection

1. Use the direction keys to scroll from line to line.
2. Press enter to select a line.
3. Use the direction keys to scroll through options within a line.
4. Press enter to select and set an option.
5. Use the direction keys to scroll to the next line.

**Please read  
before configuring  
Room EQ Setup**

The Room EQ Setup accesses the Digital Room Equalizer, a feature designed by Krell to provide every adjustment from simple bass and treble to comprehensive room correction. The Digital Room Equalizer enables you to adjust frequency response through three discrete bands (I, II, and III). The four adjustable parameters available are filter type, frequency, shape, and level.

There are four Room EQ setup memories, each of which saves every parameter set for every filter, for every channel. Each setup memory can save a configuration, for example, one for stereo music, one for multichannel music, one for movie surround, and one for video game software.

You can adjust the filters for the Home Theater Standard 7.1 channels globally or individually. Up to three filters can be configured to act equally on all seven channels of audio. Alternatively, each filter can be configured separately for each individual channel.

**ADJUSTABLE PARAMETERS**

TYPE

Six filter types are available for each filter: Notch Filter, Peaking Filter, High Shelf Filter, Low Shelf Filter, High Pass Filter (HPF) and Low Pass Filter (LPF). Each of the filter types available has a unique effect on frequency response.

The following three parameters for filters may be configured, depending on the filter type selected:

FREQ

The center/cutoff frequency can be specified for all six filter types, from 20 Hz to 16 kHz in 1/3 octave increments.

SHAPE

Shape controls the bandwidth of the filter and is adjustable on the Notch and Peaking filter types, from 0.4 to 9 octaves. Shape is fixed at a 6 dB / octave slope for the High and Low Pass Filters. This parameter is not available for the High and Low Shelf Filters.

**How To Navigate the Menu  
and Make a Selection**

1. Use the direction keys to scroll from line to line.
2. Press enter to select a line.
3. Use the direction keys to scroll through options within a line.
4. Press enter to select and set an option.
5. Use the direction keys to scroll to the next line.

LEVEL

Level is adjustable on the Peaking, High Shelf and Low Shelf filters, from -12 dB to +6 dB. Level is fixed for the Notch Filter at -90 dB. This parameter is not available for the High and Low Pass Filters.

---

**System Configuration, continued**

**CHANNEL SELECTION** When the channel field is set to ALL, the ROOM EQ SETUP menu displays the filter settings which apply to all channels and all of the channels are filtered in the same manner. When the channel parameter selection is set to only one of the channels (L, C, R, LS, RS, LB, RB, S), the filter settings apply to each of the channels individually.

---

**IMPORTANT** *The selection ALL overrides individually configured channels.*

**APPLYING YOUR CONFIGURATIONS** Your configurations take effect only when you press enter in the APPLY field. APPLY allows you to hear the effect of the selections you have made without leaving the menu, if you have a source device playing.

**SAVING ROOM EQ SETUP MEMORY** There are four selectable memories associated with the ROOM EQ SETUP menu. Values are saved automatically when you enter a selection.

Room EQ settings are stored in the Home Theater Standard 7.1 memory in the same manner as all of the other software settings, for example the selections for loudspeaker setup and device configuration. See ***Saving and Recalling Customized Settings and Restoring the Factory Default System Settings***, on page 67, for more information.

**ACCESSING ROOM EQ SETUP MEMORY** When the Home Theater Standard 7.1 is in the operational mode, access the saved EQ configurations by pressing the right (arrow) key on the remote. Use the up and down (arrow) remote keys to scan through the four memories and OFF.

---

**Note** *Exit the main configuration menu by pressing the menu key (82) on the remote. The Home Theater Standard 7.1 is now in operational mode. Press the right arrow directional key followed by the up and down directional keys (75) to scroll through the four EQ memories and OFF.*

## Room EQ Setup

The final item on the OPERATION menu, ROOM EQ SETUP, allows you to adjust your loudspeaker to your listening area using the Krell Digital Room Equalizer. Select ROOM EQ SETUP from the OPERATION menu. The ROOM EQ SETUP screen appears, with the cursor blinking at OFF:

### Room EQ Setup Screen

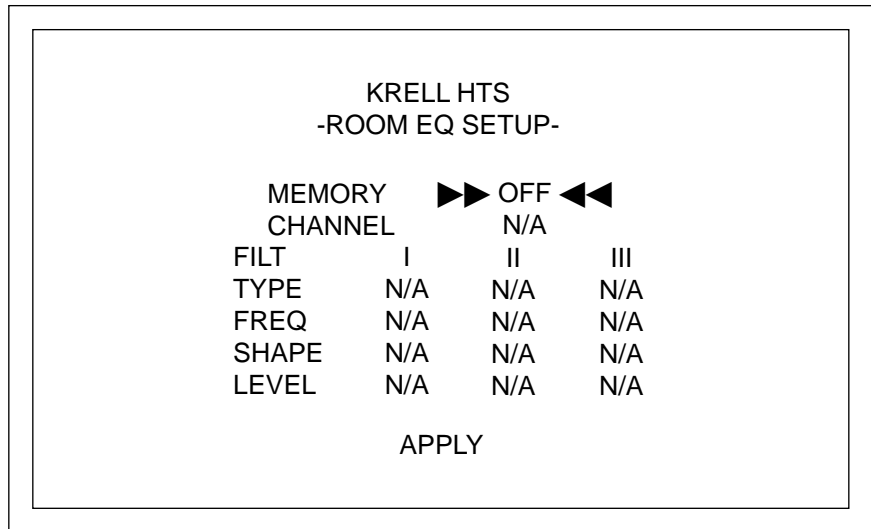

Use the direction and enter keys on the Home Theater Standard 7.1 remote control to scroll through and select the following step-by-step options for audio operation:

#### MEMORY

Navigate to one of the four memory locations and enter your selection. When the Memory field is set to OFF (the factory default), all of the filters are disabled.

#### CHANNEL

Navigate to CHANNEL and select ALL to apply your configurations to all channels at once or select any individual channel to apply your configurations to that channel. Enter your selection.

---

### **IMPORTANT**

***The selection ALL overrides individually configured channels.***



---

## System Configuration, continued

### Room EQ Setup continued

#### TYPE

Navigate to TYPE, and configure one, two, or all of the three bands (I, II, III) for FREQ, SHAPE, and LEVEL.

#### Note

*It is not necessary to configure all three filters, you may configure only one or two filters.*

*Some parameters may be adjusted, depending on the filter type selected.*

#### APPLY

Select APPLY and set the selection, if you want to hear your configuration. The Room EQ Setup configurations you have just selected are audible if you have a source playing.

After selecting the appropriate loudspeaker configuration for your system, press the previous key twice to return to the main configuration menu.

Exit the main configuration menu by pressing the menu key on the remote. The Home Theater Standard 7.1 is now in the operational mode.

### How To Navigate the Menu and Make a Selection

1. Use the direction keys to scroll from line to line.
2. Press enter to select a line.
3. Use the direction keys to scroll through options within a line.
4. Press enter to select and set an option.
5. Use the direction keys to scroll to the next line.

---

# Saving and Recalling Customized Settings and Restoring the Factory Default System Settings

## SAVING CUSTOMIZED SETTINGS

To save the customized settings that you have entered, press and hold the save button (29) for approximately four seconds. The front panel displays **SAVING SETUP** while the settings are being stored in the nonvolatile memory of the Home Theater Standard 7.1.

## RECALLING CUSTOMIZED SETTINGS

To retrieve your system's saved settings, press and hold the recall button (31) for approximately four seconds. The front panel displays **RECALL SETUP** while the settings are being retrieved from the Home Theater Standard's nonvolatile memory. Any settings that have been saved will be available through recalling system setup.

## RESTORING THE FACTORY DEFAULT SYSTEM SETTINGS

To replace all system settings with the factory default settings, follow these steps:

1. Press the front panel power button (1) to put your system into the operational mode.
2. Simultaneously press the recall button (31) and the power button (1). The front panel displays:

PLEASE WAIT

INITIALIZING

Your customized settings for the Home Theater Standard 7.1 revert to the factory default settings.

---

### **Note**

*If you save your settings, they are still in memory after you restore the factory default system settings. Follow **Recalling Customized Settings** above to retrieve your customized settings.*

---

# Operating the Home Theater Standard 7.1

## ON/OFF/STAND-BY

After the Home Theater Standard 7.1 is connected to sources and amplifiers, and the system is configured, the Home Theater Standard 7.1 is ready for operation.

1. Insert the AC power cord into the IEC connector (56) on the Home Theater Standard 7.1. Insert the other end into the AC wall receptacle.
2. Move the back panel power switch (55) into the up (on) position.
3. The red stand-by LED on the front panel illuminates. The words PLEASE WAIT, INITIALIZING appear in the front panel display (25), followed by the model name, software version, and the AC line frequency. After 5 seconds the initializing message disappears, and the front panel display becomes blank. The Home Theater Standard 7.1 is ready to be powered on.

After five seconds of inactivity, the display becomes blank.

4. Use either the front panel power button (1) or the remote control power pre key (58) to power on the Home Theater Standard 7.1. The blue power LED (2) on the front panel illuminates. The Home Theater Standard 7.1 is now in the operational mode.
5. To return to stand-by, press the front panel power button or power pre key again.

---

### Note

*Krell recommends that the back panel power switch remain up (on) at all times.*

## TAPE INPUT AND OUTPUT

The Home Theater Standard 7.1 has a discrete tape input and output. The tape output is used to send an input signal from any analog input (S-1 through S-7, B-1, or VCR1) to a recording source or processor. You can use the tape feature in three ways:

1. Use the tape input to playback pre-recorded tapes.
2. Use the tape input to compare the output signal of a three-head analog tape recorder to the output signal of an audio source. Press the tape button (14) or key (70) to switch between the tape recorder output (LED illuminated) and the input source (LED not illuminated).

Press and hold a device key for three seconds, after the device has been selected, to change the tape output source bus to the currently selected zone. Tape out can come from the main zone or zone 2.

**Tape Input and Output,**  
*continued*

3. Use the tape output to create a processor loop, when the Home Theater Standard 7.1 is connected to a graphic equalizer or other ancillary equipment. Connect the equipment to the Home Theater Standard 7.1 tape outputs (37) as described in the equipment manufacturer's manual. Press the tape button (14) or key (70) to switch between the processor output (LED illuminated) and the input source (LED not illuminated).

---

**Notes**

*The tape output functions only with analog sources.*

*There is no tape output from the 7.1 multichannel input.*

*When changing sources, lower the volume to off or mute the output. This ensures that the next source played does not damage your system with a high output transient.*

**MAIN ZONE AND  
ZONE 2 OPERATION**

The Home Theater Standard 7.1 has two audio zones, main and zone 2. The main zone consists of the main viewing or listening area, and zone 2 consists of another listening area. You can select a digital or analog audio, or a video device for the main zone. Zone 2 can only be used with an analog audio device. To configure a device that has both digital and analog outputs, see **Configure Devices**, on page 38.

The Home Theater Standard 7.1 two-zone operation offers a number of listening options.

- You can play both zones simultaneously, with the main zone playing a source in one part of the house and zone 2 playing a different (or the same) source in another part of the house.
- With the Home Theater Standard 7.1 in operational or stand-by mode, you can activate the main zone only. Or, while the Home Theater Standard 7.1 is still in stand-by mode, you can set up zone 2 listening so that when you switch to operational mode, only zone 2 plays.
- You can play a source using the main zone while using zone 2 to record.

The red LED illuminates when the input is engaged and playing in the main zone. The green LED illuminates when the input is engaged and playing in zone 2. You can set the zone 2 output to be fixed or variable, see **Configure Level Adjustment**, on page 47.

### **Play Both Zones**

With the Home Theater Standard 7.1 in the stand-by mode:

1. Press and release the power pre key (58) until the blue power LED illuminates.
2. Press the input device selection button or key for the source you wish to play.
3. Begin playing the source and adjust the volume to your liking.
4. Press the Z2 key (60).
5. Press the input device selection button or key for another source to play in zone 2. Or select the same input device button if you want the same source to play in both zones.
6. Begin playing the source and adjust the volume to your liking.
7. Press the power pre key again to turn off zone 2.
8. Press the Z2 key and the power pre key again to turn off the main zone.

### **Play Either Zone**

#### **MAIN ZONE**

With the Home Theater Standard 7.1 in the stand-by mode:

1. Press the power pre key (58) to activate the main zone.
2. Select the source you wish to play.
3. Press power pre key again to turn off the main zone.

#### **ZONE 2**

With the Home Theater Standard 7.1 in the stand-by mode:

1. Press the Z2 key (60) to activate zone 2.
2. Select the source you wish to play; it will play only in zone 2.
3. Press the Z2 key again to turn off zone 2.

For additional remote control options, see ***RS-232 Port: Sending Commands and Interpreting Data***, the developer's reference for the Home Theater Standard 7.1.

**Play in the Main Zone  
and Record  
in Zone 2**

1. Press the power pre key (58), then select the input device that you want to play through the main zone. The main zone LED illuminates. Begin playing the device.
2. To record at the same time, press the Z2 key (60), then select the source that you want to record by pressing the input device selection key. After the zone 2 device LED illuminates, press the input device selection key again. The front panel display reads:  
TAPE OUT CHANGED TO ZONE 2  
Start playing the source that you wish to record. Recording begins when you start playing the source.
3. To monitor the output being recorded, switch back to the main zone, then press the input device selection key for the device being recorded. The material being recorded plays through the main zone.
4. Press the input selected for main zone playback to return the main zone to playing its original material. The recording will continue uninterrupted through zone 2.

**SIMULCAST**

When you are listening to or viewing a number of sources with devices that have different trigger settings (configured through the setup menus), you can retain a trigger setting using the previous (80) key.

For example, you have configured your Home Theater Standard 7.1 to turn on your TV monitor when trigger 4 is on and your CD player is set for TRIGGER 4 OFF. You want to watch TV and listen to a CD at the same time. If you press the TV button or key followed by the CD button or key, the TV monitor will turn off.

To keep the monitor on and turn on the CD player, follow these steps:

1. Press the TV button (9) or key (64) to select the device. Begin playing the source.
2. Press the prev key (80).
3. Press the CD button (10) or key (65). Begin playing the source.

---

# Appendix: Operating Modes for the Home Theater Standard 7.1

## AUTOMATICALLY DETECTED MODES

---

### Note

*The DOLBY DIGITAL EX, DOLBY D 5.1 + THX SURR EX, DTS-ES DISCRETE 6.1, and DTS-EX MATRIX 6.1 operating modes are available only when your system has 6 or 7 channels.*

The Home Theater Standard 7.1 automatically detects the following signals and automatically engages the appropriate operating mode for the following signals. Available default modes are listed in **Table 4**, see page 44:

#### DOLBY DIGITAL 2.0 OR DOLBY DIGITAL 2.0 + DOLBY PRO LOGIC

Select a Dolby Digital 2.0 or Dolby Digital 2.0 + Dolby Pro Logic default mode using the configuration menu. All modes listed under Dolby Digital 2.0, including the default mode you have selected, can be accessed using the M2 button or key.

#### DOLBY DIGITAL 5.1

Select a Dolby Digital 5.1 default mode using the configuration menu. All modes listed under Dolby Digital 5.1, including the default mode you have selected, can be accessed using the M2 button or key.

#### DOLBY DIGITAL EX

Dolby Digital EX creates six full-bandwidth output channels from 5.1-channel sources. This is done using a matrix decoder that derives three surround channels from the two in the original recording. For best results, Dolby Digital EX should be used with movie soundtracks recorded with Dolby Digital Surround EX. All modes listed under Dolby Digital EX, including the default mode you have selected, can be accessed using the M2 button or key.

#### DTS 5.1

Select a DTS 5.1 default mode using the configuration menu. All modes listed under DTS 5.1, including the default mode you have selected, can be accessed using the M2 button or key.

#### DTS-ES DISCRETE 6.1

The Home Theater Standard 7.1 engages DTS-ES Discrete 6.1 decoding. All of the following modes, plus DTS-ES DISCRETE 6.1 can be accessed using the M2 button or key: DTS-ES DISCRETE 6.1 + THX, DTS-ES MATRIX 6.1, DTS-ES MATRIX 6.1 + THX, DTS 5.1 MOVIE, DTS 5.1 MOVIE + THX, and DTS 5.1 MUSIC.

#### DTS-ES MATRIX 6.1

The Home Theater Standard 7.1 engages DTS ES Matrix 6.1 decoding. All of the following modes plus DTS-ES MATRIX 6.1 can be accessed using the M2 button or key: DTS-ES MATRIX 6.1 + THX, DTS 5.1 MOVIE, DTS 5.1 MOVIE + THX, and DTS 5.1 MUSIC.

#### THX SURROUND EX

The Home Theater Standard 7.1 engages THX Surround EX decoding. The following modes, plus THX SURROUND EX in M1, can be accessed using the M2 button or key or the THX button or key: DOLBY D 5.1 and DOLBY D 5.1 + THX.

**USER SELECTABLE  
MODES**

**Dolby Pro Logic II  
Modes**

User selectable modes available on the Home Theater Standard 7.1 are listed below:

**DOLBY PRO LOGIC II**

Dolby Pro Logic II is the next generation in Dolby Surround decoding. The Pro Logic II decoder takes 2 channels in and 5 channels out. It is designed specifically to decode all existing Dolby Surround programs with improved spatiality and directionality. Pro Logic II is also designed for use with unencoded stereo music recordings. This feature draws the listener into a three-dimensional space rather than hearing a flat, two-dimensional presentation.

There are 4 modes in which the Pro Logic II decoder can operate: movie mode (DOLBY PLII MOVIE), music mode (DOLBY PLII MUSIC), matrix mode (DOLBY PLII MATRIX), and Pro Logic mode (DOLBY PRO LOGIC):

**DOLBY PLII MOVIE**

The movie mode is the improved counterpart to the original Pro Logic decoder. It is the choice for the majority of Dolby Surround encoded material.

**DOLBY PLII MUSIC**

The music mode is for use with unencoded stereo music recordings. The music mode features dimension and center width controls, see **PLII Control**, on page 55, to enhance the music surround experience.

**DOLBY PLII MATRIX**

The matrix mode is useful for monaural recordings.

**DOLBY PRO LOGIC**

The Dolby Pro Logic mode provides the same surround processing as the original Pro Logic and is best used with source content that is not of optimum quality.

**THX and  
THX Surround EX  
Modes**

**THX**

THX post processing can be added to Dolby Surround, Dolby Digital, and DTS encoded material, and includes the following algorithms:

- Re-Equalization takes the edginess or brightness out of your home cinema sound.
- Timbre Matching matches the tone of your front loudspeakers to your surround loudspeakers.
- Adaptive Decorrelation gives a stereo feel when your surround source is mono. Adaptive Decorrelation automatically switches off when the surround source is stereo.
- Bass Management Electronic Crossover allows you to use more compact, easier-to-place loudspeakers, while sending bass to a



**Appendix: Additional Operating Modes  
for the Home Theater Standard 7.1, continued**

**THX and THX Surround EX  
Modes, continued**

subwoofer system, improving frequency response, lowering distortion and increasing dynamic range.

- Bass Peak Level Manager protects the subwoofer from overloading due to the great amount of bass a 5.1 soundtrack delivers.
- Loudspeaker Position Time Synchronization lets you easily set up your system for an optimum listening position.

**THX SURR EX**

THX Surround EX is a process that decodes a back surround signal from the left and right surround channels on specially encoded Dolby Digital DVD movie releases. THX Surround EX uses all the processing included in the THX operating mode (see above). Your system must include one or two back/surround loudspeakers for THX Surround EX to operate.

**Note**

*If the DVD has the proper encoding, the Home Theater Standard 7.1 will recognize THX Surround EX and automatically engage the signal. Many DVD discs include THX Surround EX information but do not encode it in a way that a surround processor can recognize.*

**DTS Neo:6 Modes**

DTS Neo:6 provides up to six full-band channels of information from stereo encoded material. 7.1 and 6.1 systems will derive six channels from the signal while 5.1 systems will derive five channels from the signal. DTS Neo:6 includes two modes: DTS NEO:6 CINEMA for two channel matrixed movie material and DTS NEO:6 MUSIC for stereo encoded music material.

**Krell Music Surround  
Modes**

The Krell Music Surround Modes simulate different soundfield experiences when listening to music. The table below lists the modes and the speakers that operate within each mode:

**Table 5 Krell Music Surround Modes for the Home Theater Standard 7.1**

<b>Operating Modes</b>	<b>Active Loudspeakers</b>
GENERAL ADMISSION	L/R/S/RR
FRONT ROW	L/R/S/RR
ON STAGE	L/R/C/S/RR
ENHANCED STEREO	L/R/C/S
ORCHESTRA	L/R/C/S/RR
MEZZANINE	L/R/C/S/RR
FULL RANGE + SUB	L/R/C/S/RR
MONOPHONIC	C/S
PARTY	L/R/C/S/RR

---

# Warranty

***To register your product for warranty benefits, please complete and return the Warranty Registration Card enclosed in the shipping box within 15 days of purchase. Thank you.***

This Krell product has a limited warranty of five years for parts and labor on circuitry. Should this product fail to perform at any time during the warranty, Krell will repair it at no cost to the owner, except as set forth in this warranty.

The warranty does not apply to damage caused by acts of God or nature.

The warranty on this page shall be in lieu of any other warranty, expressed or implied, including, but not limited to, any implied warranty of merchantability or fitness for a particular purpose. There are no warranties which exceed beyond those described in this document. If this product does not perform as warranted herein, the owner's sole remedy shall be repair. In no event will Krell be liable for incidental or consequential damages arising from purchase, use, or inability to use this product, even if Krell has been advised of the possibility of such damages.

Proof of purchase in the form of a bill of sale or receipted invoice substantiating that the unit is within the warranty period must be presented to obtain warranty service. The warranty begins on the date of the original retail purchase, as noted on the bill of sale or receipted invoice from an authorized Krell dealer or distributor. Previously owned equipment, when re-purchased from an authorized Krell dealer or distributor, has the balance of the original warranty, based on the original date of manufacture.

The warranty for Krell products is valid only in the country to which they were originally shipped, through the authorized Krell distributor for that country, and at the factory. There may be restrictions on or changes to Krell's warranty because of regulations within a specific country. Please check with your distributor for a complete understanding of the warranty in your country.

If a unit is serviced by a distributor who did not import the unit, there may be a charge for service, even if the product is within the warranty period.

Freight to the factory is your responsibility. Return freight within the United States (U.S.A.) is included in the warranty. If you purchased your Krell product outside the U.S.A. and wish to have it serviced at the factory, all freight and associated charges to the factory are your responsibility. Krell will pay return freight to the U.S.A.-based freight forwarder of your choice. Freight and other charges to ship the unit from the freight forwarder to you are also your responsibility.

Krell is not responsible for any damage incurred in transit. Krell will file claims for damages as necessary for units damaged in transit to the factory. You are responsible for filing claims for shipping damages during the return shipment.

Krell does not supply replacement parts and/or products to the owner of the unit. Replacement parts and/or products will be furnished only to the distributor performing service on this unit on an exchange basis only; any parts and/or products returned to Krell for exchange become the property of Krell.

No expressed or implied warranty is made for any Krell product damaged by accident, abuse, misuse, natural or personal disaster, or unauthorized modification.

**Any unauthorized voltage conversion, disassembly, component replacement, perforation of chassis, updates, or modifications performed to the unit will void the warranty.**

The operating voltage of this unit is determined by the factory and can only be changed by an authorized Krell distributor or at the factory. The voltage for this product in the U.S.A. cannot be changed until six months from the original purchase date.

In the event that Krell receives a product for warranty service that has been modified in any way without Krell authorization, all warranties on that product will be void. The product will be returned to original factory layout specifications at the owner's expense before it is repaired. All repairs required after the product has been returned to original factory specifications will be charged to the customer, at current parts and labor rates.

All operational features, functions, and specifications and policies are subject to change without notification.

---

# Return Authorization Procedure

## HOW TO EXPEDITE SERVICE

If you believe there is a problem with your component, please contact your dealer, distributor, or the Krell factory to discuss the problem *before* you return the component for repair. To expedite service, you may wish to complete and e-mail the Service Request Form in the Service section of our website at:

<http://www.krellonline.com>

### To contact the Krell Service Department:

TEL	203-799-9954 Monday-Friday, 9:00 AM to 5:00 PM EST
FAX	203-799-9796
E-MAIL	<a href="mailto:service@krellonline.com">service@krellonline.com</a>
WEB SITE	<a href="http://www.krellonline.com">http://www.krellonline.com</a>

## HOW TO RETURN A PRODUCT

To return a product to Krell, please follow this procedure so that we may serve you better:

1. Obtain a Return Authorization Number (R/A number) and shipping address from the Krell Service Department.
2. Insure and accept all liability for loss or damage to the product during shipment to the Krell factory and ensure all freight (shipping) charges are prepaid.

The product may also be hand delivered if arrangements with the Service Department have been made in advance. Proof of purchase will be required for warranty validation at the time of hand delivery.

---

### **IMPORTANT**

***Use the original packaging to ensure the safe transit of the product to the factory, dealer, or distributor. Krell may, at its discretion, return a product in new packaging and bill the owner for such packaging if the product received by Krell was boxed in nonstandard packaging or if the original packaging was so damaged that it was unusable. If Krell determines that new packaging is required, the owner will be notified before the product is returned.***

## HOW TO PURCHASE ADDITIONAL PACKING

To purchase additional packaging, please contact your authorized Krell dealer, distributor, or the Krell Service Department for assistance.

## SERIAL NUMBER

Your Home Theater Standard 7.1 product serial number is:

---

---

# Specifications

<b>SIGNAL-TO-NOISE RATIO</b>	"A" WEIGHTED	94 dB
<b>TOTAL HARMONIC DISTORTION (THD)</b>	UNWEIGHTED	20 Hz-20 kHz, -88 dB
<b>INPUTS</b>	ANALOG AUDIO	1 pair balanced via XLR connectors 7 pairs single-ended via RCA connectors one 7.1 via RCA connectors
	DIGITAL AUDIO	6 coaxial via RCA connectors 2 EIAJ optical via TosLink connectors
	VIDEO	4 S-video via DIN connectors 4 composite via RCA connectors 2 component via RCA connector
	ANALOG TAPE	2 pair single-ended via RCA connectors
<b>OUTPUTS</b>	ANALOG CHANNEL (one per channel) (one per channel)	8 balanced via XLR connectors 8 single-ended via RCA connectors 1 multi-channel via a DB-25 connector
	ANALOG TAPE	1 pair single-ended via RCA connectors
	DIGITAL	1 coaxial via RCA connector 1 EIAJ optical via TosLink connectors
	VIDEO	2 S-video via DIN connector, 1 with OSD 2 composite via RCA connectors, 1 with OSD 1 component via RCA connectors with OSD
	<b>ZONE 2 AND REMOTE</b>	ZONE 2 REMOTE CONTROL
	REMOTE CONNECTORS	1 RS-232 1 RC-5 input 4 12 VDC OUT (12 V trigger) 1 12 VDC IN (12 V trigger)
<b>DECODING MODES</b>		Dolby Pro Logic II Dolby Digital 5.1 Dolby Digital EX DTS 5.1 DTS ES Discrete 6.1 DTS ES Matrix 6.1 THX Surround EX DTS Neo:6

---

**Specifications, continued**

---

<b>SURROUND ENHANCEMENT MODES</b>	KRELL MUSIC SURROUND	General Admission Front Row On Stage Enhanced Stereo Orchestra Mezzanine Full Range + Sub Monophonic Party
-----------------------------------	----------------------	--

---

<b>DIMENSIONS</b>	INCHES	17.3w x 5.7h x 16.3d
	CENTIMETERS	43.9w x 14.5h x 41.4d

---

<b>WEIGHT</b>	SHIPPING	26 lb.	11.8 kg
	UNIT ONLY	20 lb.	9 kg

*All operational features, functions, specifications, and policies are subject to change without notification.*

Krell Industries, Inc.  
45 Connair Road  
Orange, CT 06477-3650 USA

TEL 203-799-9954  
FAX 203-891-2028  
E-MAIL [krell@krellonline.com](mailto:krell@krellonline.com)  
WEBSITE <http://www.krellonline.com>

# Home Theater Standard 7.1

Surround

Preamp/Processor

v 02.3

---